



7270

7270

# BEAM POWER TUBE

FORCED-AIR COOLED AT MAXIMUM RATINGS

315 Watts CW Input (ICAS) up to 60 Mc

235 Watts CW Input (ICAS) at 175 Mc

## GENERAL DATA

### Electrical:

Heater, for Unipotential Cathode:

Voltage (AC or DC) . . . . .	6.3 ± 10%	volts
Current at 6.3 volts. . . . .	3.1	amp

Mu-Factor, grid No.2 to grid No.1

for plate volts = 250, grid-No.2	
volts = 250, and plate ma. = 100. . . . .	8

Direct Interelectrode Capacitances

(Approx):<sup>o</sup>

Grid No.1 to plate. . . . .	0.4	μf
Grid No.1 to grid No.2 &		
internal shield . . . . .	10	μf
Grid No.1 to cathode and heater . . . . .	8	μf
Grid No.2 & internal shield		
to plate. . . . .	10	μf
Grid No.2 & internal shield		
to cathode and heater . . . . .	2.2	μf
Plate to cathode and heater . . . . .	0.14	μf
Heater to cathode . . . . .	17	μf

### Mechanical:

Operating Position. . . . .	Any
Maximum Overall Length. . . . .	4.65"
Seated Length . . . . .	4.08" ± 0.08"
Maximum Diameter. . . . .	2.06"
Weight (Approx.). . . . .	3.5 oz
Bulb. . . . .	T16
Socket. . . . .	Johnson No.122-105*, or equivalent
Base. . . . .	Large-Button Septar 7-Pin (JEDEC No.E7-55)

### BOTTOM VIEW

- Pin 1-Heater
- Pin 2-Heater
- Pin 3-Grid No.2,  
  Internal  
  Shield
- Pin 4-Cathode

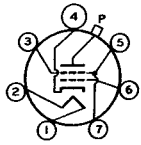

- Pin 5-Grid No.2,  
  Internal  
  Shield
- Pin 6-Grid No.1
- Pin 7-Grid No.2,  
  Internal  
  Shield
- P-Plate

**Cooling**—Free circulation of air around the tube is required. Under operating conditions at maximum ratings, some forced-air cooling will be required from a small fan to prevent exceeding the specified maximum bulb temperature.

Bulb Temperature (At hottest point) . . . . . 250 max. °C

7270



7270

## BEAM POWER TUBE

AF POWER AMPLIFIER & MODULATOR — Class AB<sub>1</sub> †

CCS\*

ICAS\*\*

## Maximum Ratings, Absolute-Maximum Values:

DC PLATE VOLTAGE. . . . .	1100 max.	1350 max.	volts
DC GRID-No.2 (SCREEN-GRID) VOLTAGE . . . . .	425 max.	425 max.	volts
MAX.-SIGNAL DC PLATE CURRENT ■ . . . .	340 max.	340 max.	ma
MAX.-SIGNAL PLATE INPUT ■ . . . .	180 max.	250 max.	watts
MAX.-SIGNAL GRID-No.2 INPUT ■ . . . .	20 max.	20 max.	watts
PLATE DISSIPATION ■ . . . . .	60 max.	80 max.	watts
PEAK HEATER-CATHODE VOLTAGE:			
Heater negative with respect to cathode. . . . .	135 max.	135 max.	volts
Heater positive with respect to cathode. . . . .	135 max.	135 max.	volts

## Typical Operation:

Values are for 2 tubes

DC Plate Voltage. . . . .	1000	1250	volts
DC Grid-No.2 Voltage § . . . . .	400	400	volts
DC Grid-No.1 (Control- Grid) Voltage** . . . . .	-50	-50	volts
Peak AF Grid-No.1-to- Grid-No.1 Voltage . . . . .	88	92	volts
Zero-Signal DC Plate Current . . . . .	78	88	ma
Max.-Signal DC Plate Current. . . . .	330	370	ma
Max.-Signal DC Grid-No.2 Current . . . . .	90	90	ma
Effective Load Resistance (Plate to plate). . . . .	6800	7880	ohms
Max.-Signal Driving Power (Approx.) . . . . .	0	0	watts
Max.-Signal Power Output (Approx.) . . . . .	190	270	watts

## Maximum Circuit Values:

Grid-No.1-Circuit Resistance. . . . .	30000 max.	30000 max.	ohms
---------------------------------------	------------	------------	------

 LINEAR RF POWER AMPLIFIER — Class AB<sub>1</sub>  
 Single-Sideband Suppressed-Carrier Service

CCS\*

ICAS\*\*

## Maximum Ratings, Absolute-Maximum Values:

Up to 60 Mc

DC PLATE VOLTAGE. . . . .	1100 max.	1350 max.	volts
DC GRID-No.2 (SCREEN-GRID) VOLTAGE . . . . .	425 max.	425 max.	volts
MAX.-SIGNAL DC PLATE CURRENT. . . . .	340 max.	340 max.	ma



7270

7270

## BEAM POWER TUBE

	CCS*		ICAS**	
MAX.—SIGNAL PLATE INPUT. . . . .	180	max.	250	max. watts
MAX.—SIGNAL GRID—No.2 INPUT. . . . .	20	max.	20	max. watts
PLATE DISSIPATION. . . . .	60	max.	80	max. watts
PEAK HEATER—CATHODE VOLTAGE:				
Heater negative with respect to cathode . . . . .	135	max.	135	max. volts
Heater positive with respect to cathode . . . . .	135	max.	135	max. volts
<b>Typical Operation:</b>				
	<i>At 60 Mc</i>			
DC Plate Voltage . . . . .	1000		1250	volts
DC Grid—No.2 Voltage\$. . . . .	400		400	volts
DC Grid—No.1 (Control—Grid) Voltage** . . . . .	-50		-50	volts
Zero—Signal DC Plate Current . . . . .	39		44	ma
Effective RF Load Resistance . . . . .	3400		3940	ohms
<i>With "Single-Tone Modulation":</i> ♦♦				
Max.—signal dc plate current. . . . .	165		185	ma
Max.—signal dc grid—No.2 current. . . . .	45		45	ma
Max.—signal peak rf grid—No.1 voltage . . . . .	44		46	volts
Max.—signal driver power output (Approx.) . . . . .	4.5		4.5	watts
Output—circuit efficiency (Approx.) . . . . .	90		90	%
Max.—signal useful power output (Approx.) . . . . .	95*		135*	watts
<i>With "Two-Tone Modulation":</i> ♦				
Average dc plate current . . . . .	122		137	ma
Average dc grid—No.2 current. . . . .	26		26	ma
Max.—resultant—signal peak rf grid—No.1 voltage . . . . .	44		46	volts
Output—circuit efficiency (Approx.) . . . . .	90		90	%
Distortion—products level:♦				
3rd order. . . . .	-26♠		-26♠	db
5th order. . . . .	-33♠		-33♠	db
Useful power output (Approx.):				
Average. . . . .	47.5*		67.5*	watts
Peak envelope. . . . .	95*		135*	watts
<b>Maximum Circuit Values:</b>				
Grid—No.1—Circuit Resistance. . . . .	30000	max.	30000	max. ohms



## BEAM POWER TUBE

**LINEAR RF POWER AMPLIFIER — Class B**  
**Single-Sideband Suppressed-Carrier Service**
*High-Mu Triode Connection*<sup>▲</sup>

CCS\*

ICAS\*\*

**Maximum Ratings, Absolute-Maximum Values:**

Up to 60 Mc

DC PLATE VOLTAGE. . . . .	1100	max.	1350	max.	volts
MAX.—SIGNAL DC PLATE CURRENT. . . . .	340	max.	340	max.	ma
MAX.—SIGNAL DC COMBINED GRIDS No.1 & No.2 CURRENT . . . . .	170	max.	170	max.	ma
MAX.—SIGNAL PLATE INPUT . . . . .	180	max.	250	max.	watts
PLATE DISSIPATION . . . . .	60	max.	80	max.	watts
PEAK HEATER-CATHODE VOLTAGE:					
Heater negative with respect to cathode. . . . .	135	max.	135	max.	volts
Heater positive with respect to cathode. . . . .	135	max.	135	max.	volts

**Typical Operation:**
*In cathode-drive circuit at 60 Mc  
with "Single-Tone Modulation"*<sup>▲▲</sup>

DC Plate-to-Grids No.1 & No.2 Voltage. . . . .	1000		1250		volts
DC Grids No.1 & No.2 Voltage . . . . .	0		0		volts
Zero-Signal DC Plate Current. . . . .	20		25		ma
Effective RF Load					
Resistance. . . . .	3400		3680		ohms
Max.—Signal DC Plate Current. . . . .	170		180		ma
Max.—Signal DC Combined Grids No.1 & No.2 Current . . . . .	108		94		ma
Max.—Signal Peak RF Cathode- to-Grids No.1 & No.2 Voltage. . . . .	40		40		volts
Max.—Signal Driver Power Output (Approx.) <sup>▲▲</sup> . . . . .	13		15		watts
Output-Circuit Efficiency (Approx.) . . . . .	90		90		%
Max.—Signal Useful Power Output (Approx.) . . . . .	100*		140*		watts

**PLATE-MODULATED RF POWER AMPLIFIER — Class C Telephony**
*Carrier conditions per tube for use  
with a maximum modulation factor of 1*

CCS\*

ICAS\*\*

**Maximum Ratings, Absolute-Maximum Values:**

 For maximum plate voltage and maximum plate  
input above 60 Mc, see Rating Chart I

DC PLATE VOLTAGE. . . . .	900	max.	1100	max.	volts
---------------------------	-----	------	------	------	-------



7270

7270

### BEAM POWER TUBE

	CCS*		ICAS**		
DC GRID-No.2 (SCREEN-GRID) VOLTAGE. . . . .	425	max.	425	max.	volts
DC GRID-No.1 (CONTROL-GRID) VOLTAGE. . . . .	-300	max.	-300	max.	volts
DC PLATE CURRENT . . . . .	280	max.	280	max.	ma
DC GRID-No.1 CURRENT . . . . .	25	max.	30	max.	ma
PLATE INPUT. . . . .	160	max.	210	max.	watts
GRID-No.2 INPUT. . . . .	13.5	max.	13.5	max.	watts
PLATE DISSIPATION. . . . .	40	max.	50	max.	watts
<b>PEAK HEATER-CATHODE VOLTAGE:</b>					
Heater negative with respect to cathode . . . .	135	max.	135	max.	volts
Heater positive with respect to cathode . . . .	135	max.	135	max.	volts
<b>Typical Operation:</b>					
<i>At 60 Mc</i>					
DC Plate Voltage . . . . .	800		1000		volts
DC Grid-No.2 Voltage <sup>▲</sup> . . . . .	400		400		volts
DC Grid-No.1 Voltage <sup>★</sup> . . . . .	-105		-107		volts
Peak RF Grid-No.1 Voltage. . . . .	110		114		volts
DC Plate Current . . . . .	175		190		ma
DC Grid-No.2 Current . . . . .	30		30		ma
DC Grid-No.1 Current (Approx.). . . . .	4		4		ma
Driver Power Output (Approx.) <sup>★,▲</sup> . . . . .	4		4		watts
Output-Circuit Efficiency (Approx.). . . . .	90		90		%
Useful Power Output (Approx.). . . . .	90*		130*		watts
<i>At 175 Mc</i>					
DC Plate Voltage . . . . .	535		665		volts
DC Grid-No.2 Voltage <sup>▲</sup> . . . . .	400		400		volts
DC Grid-No.1 Voltage <sup>★</sup> . . . . .	-115		-119		volts
DC Plate Current . . . . .	200		220		ma
DC Grid-No.2 Current . . . . .	15		15		ma
DC Grid-No.1 Current (Approx.). . . . .	6		6		ma
Driver Power Output (Approx.) <sup>▲</sup> . . . . .	10		10		watts
Output-Circuit Efficiency (Approx.). . . . .	85		85		%
Useful Power Output (Approx.). . . . .	60*		85*		watts
<b>Maximum Circuit Values:</b>					
Grid-No.1-Circuit Resistance <sup>‡</sup> . . . . .	30000	max.	30000	max.	ohms

7270



7270

BEAM POWER TUBE

RF POWER AMPLIFIER & OSCILLATOR — Class C Telegraphy†  
 and  
 RF POWER AMPLIFIER — Class C FM Telephony  
 CCS\* ICAS\*\*

Maximum Ratings, Absolute-Maximum Values:

For maximum plate voltage and maximum plate input above 60 Mc, see Rating Chart II

DC PLATE VOLTAGE . . . . .	1100 max.	1350 max.	volts
DC GRID-No.2 (SCREEN-GRID) VOLTAGE . . . . .	425 max.	425 max.	volts
DC GRID-No.1 (CONTROL-GRID) VOLTAGE . . . . .	-300 max.	-300 max.	volts
DC PLATE CURRENT . . . . .	340 max.	340 max.	ma
DC GRID-No.1 CURRENT . . . . .	25 max.	30 max.	ma
PLATE INPUT . . . . .	235 max.	315 max.	watts
GRID-No.2 INPUT . . . . .	20 max.	20 max.	watts
PLATE DISSIPATION . . . . .	60 max.	80 max.	watts
PEAK HEATER-CATHODE VOLTAGE:			
Heater negative with respect to cathode. . . . .	135 max.	135 max.	volts
Heater positive with respect to cathode. . . . .	135 max.	135 max.	volts

Typical Operation:

At 60 Mc

DC Plate Voltage . . . . .	1000	1250	volts
DC Grid-No.2 Voltage <sup>■</sup> . . . . .	300	300	volts
DC Grid-No.1 Voltage <sup>⊕</sup> . . . . .	-79	-80	volts
Peak RF Grid-No.1 Voltage . . . . .	98	111	volts
DC Plate Current . . . . .	225	250	ma
DC Grid-No.2 Current . . . . .	25	30	ma
DC Grid-No.1 Current (Approx.) . . . . .	5	5	ma
Driver Power Output (Approx.) <sup>*,▲</sup> . . . . .	4	4	watts
Output-Circuit Efficiency (Approx.) . . . . .	90	90	%
Useful Power Output (Approx.) . . . . .	160*	225*	watts

Typical Operation:

At 175 Mc

DC Plate Voltage . . . . .	650	850	volts
DC Grid-No.2 Voltage <sup>■</sup> . . . . .	400	400	volts
DC Grid-No.1 Voltage <sup>⊕</sup> . . . . .	-99	-100	volts
DC Plate Current . . . . .	265	275	ma
DC Grid-No.2 Current . . . . .	15	15	ma
DC Grid-No.1 Current (Approx.) . . . . .	7.5	8	ma
Driver Power Output (Approx.) <sup>▲</sup> . . . . .	10	10	watts



7270

7270

## BEAM POWER TUBE

	CCS*	ICAS**	
Output-Circuit Efficiency (Approx.) . . . . .	85	85	%
Useful Power Output (Approx.) . . . . .	95*	135*	watts

**Maximum Circuit Values:**

Grid-No.1-Circuit Resistance‡. 30000 max. 30000 max. ohms

○ Without external shield.

\* E.F. Johnson Company, Waseca, Minnesota.

◆ Subscript 1 indicates that grid-No.1 current does not flow during any part of the input cycle.

● Continuous Commercial Service.

●● Intermittent Commercial and Amateur Service.

■ Averaged over any audio-frequency cycle of sine-wave form.

⊙ Obtained preferably from a fixed supply.

\*\* Obtained from a fixed supply.

⊕ "Single-Tone Modulation" operation refers to that class of amplifier service in which the input consists of a monofrequency rf signal having constant amplitude. This signal is produced in a single-sideband suppressed-carrier system when a single audio frequency of constant amplitude is applied to the input of the system.

⊕ "Two-Tone Modulation" operation refers to that class of amplifier service in which the input consists of two equal monofrequency rf signals having constant amplitude. These signals are produced in a single-sideband suppressed-carrier system when two equal-and-constant-amplitude audio frequencies are applied to the input of the system.

\* This value of useful power is measured at load of output circuit having indicated efficiency.

◆ Referenced with respect to the peak envelope power output obtained at maximum drive.

⊕ Maximum encountered at any driving level up to 100%.

▲ Grids No.1 and No.2 connected together.

▲▲ Driver stage is required to supply tube losses and rf-circuit losses. The driver stage should be designed to provide an excess of power above the indicated values to take care of variations in line voltage, in components, in initial tube characteristics, and in tube characteristics during life.

▲ Obtained preferably from a separate source modulated along with the plate supply, or from the modulated plate supply through a series resistor. It is recommended that this resistor be adjustable to permit obtaining the desired operating plate current after initial tuning adjustments are made.

★ Obtained from a grid-No.1 resistor or from a combination of grid-No.1 resistor with either fixed supply or cathode resistor. The combination of grid resistor and fixed supply has the advantage of not only protecting the tube from damage through loss of excitation but also of minimizing distortion by bias-supply compensation.

⊕ Indicated values are for operation at 60 Mc. Less driver power output is required at frequencies below 60 Mc.

† If this value is insufficient to provide adequate bias, the additional required bias must be supplied by a cathode resistor or fixed supply.

† Key-down conditions per tube without amplitude modulation. Amplitude modulation essentially negative may be used if the positive peak of the audio-frequency envelope does not exceed 115% of the carrier conditions.

■ Obtained preferably from a separate source or from the plate-voltage supply with a voltage divider. If a series resistor is used, it should be adjustable to permit obtaining the desired operating plate current after initial tuning adjustments are completed. Grid-No.2 voltage must not exceed 500 volts under key-up conditions.

⊕⊕ Obtained from a grid-No.1 resistor, or from a combination of grid-No.1 resistor with either fixed supply or cathode resistor.

7270



7270

## BEAM POWER TUBE

## OPERATING CONSIDERATIONS

*Shielding* of the 7270 in rf service is required for stable operation. A convenient method of shielding is to mount the socket approximately 5/8" beneath a hole in the chassis plate so that when the 7270 is inserted in the socket, the internal shield (*See Dimensional Outline*) of the tube will be close to the edge of the hole and in the same plane as the chassis plate. This arrangement provides an effective shield to isolate the grid-No.1 circuit from the plate circuit.

The *connection to the plate terminal* should be flexible in order to prevent subjecting the plate-terminal seal to any strain. The connection should never be soldered to the plate terminal. A plate connector of the heat-radiating type is recommended.

The *plate* shows no color when the 7270 is operated at maximum rated plate dissipation under CCS conditions. At maximum rated plate dissipation under ICAS conditions, the plate may show a barely discernible color in a dark room.





7270

7270

# BEAM POWER TUBE

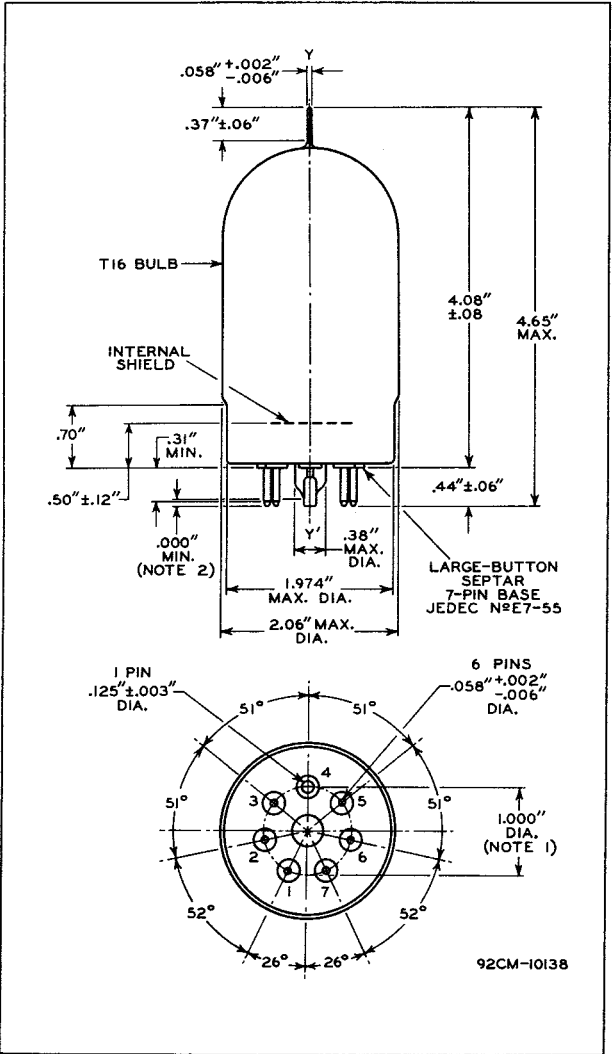

7270



7270

## BEAM POWER TUBE

THE REFERENCE AXIS  $Y-Y'$  IS DEFINED AS THE AXIS OF THE BASE-PIN GAUGE DESCRIBED IN NOTE 1:

**NOTE 1:** ANGULAR VARIATIONS BETWEEN PINS AND VARIATION IN PIN-CIRCLE DIAMETER ARE HELD TO TOLERANCES SUCH THAT PINS WILL ENTER TO A DISTANCE OF 0.375" A FLAT-PLATE BASE-PIN GAUGE HAVING SIX HOLES  $0.0800" \pm 0.0005"$  AND ONE HOLE  $0.1450" \pm 0.0005"$  ARRANGED ON A  $1.0000" \pm 0.0005"$  CIRCLE AT SPECIFIED ANGLES WITH TOLERANCE OF  $\pm 5'$  FOR EACH ANGLE. GAUGE IS ALSO PROVIDED WITH A HOLE  $0.500" \pm 0.010"$  CONCENTRIC WITH PIN CIRCLE WHOSE CENTER IS ON THE AXIS  $Y-Y'$ .

**NOTE 2:** EXHAUST TIP WILL NOT EXTEND BEYOND THE PLANE WHICH PASSES THROUGH THE ENDS OF THE THREE LONGEST PINS.



7270

7270

### RATING CHART I CLASS C TELEPHONY SERVICE

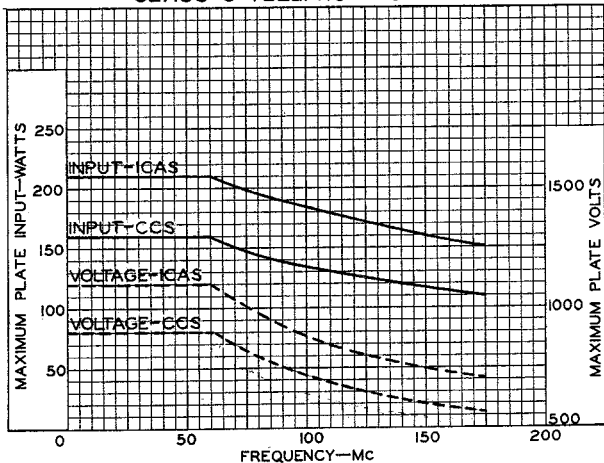

92CS-10155

### RATING CHART II CLASS C TELEGRAPHY SERVICE

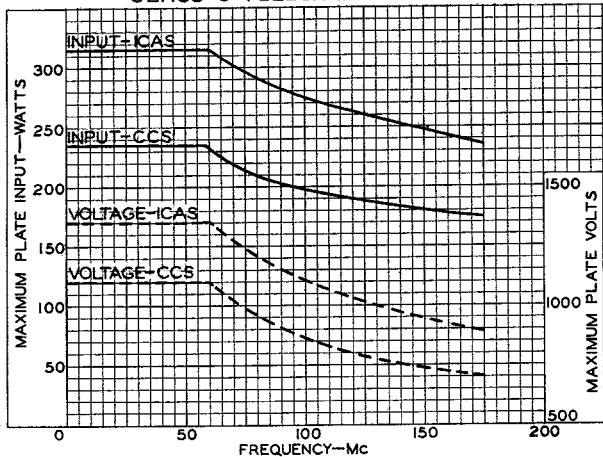

92CS-10156

7270



7270

## TYPICAL PLATE CHARACTERISTICS

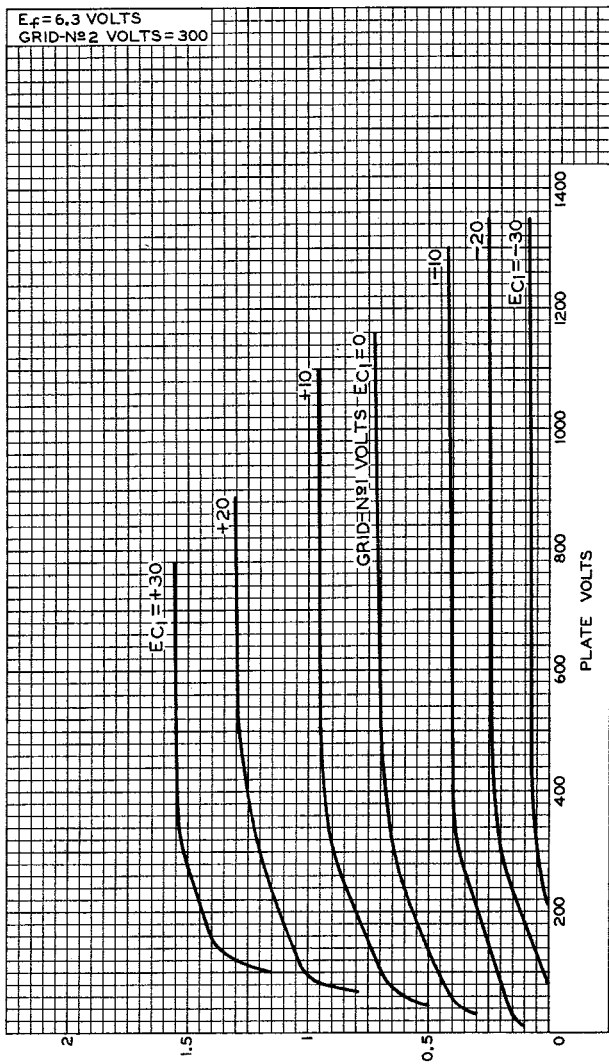

PLATE AMPERES

ELECTRON TUBE DIVISION

RADIO CORPORATION OF AMERICA, HARRISON, NEW JERSEY

92CM-10157



7270

7270

### TYPICAL PLATE CHARACTERISTICS

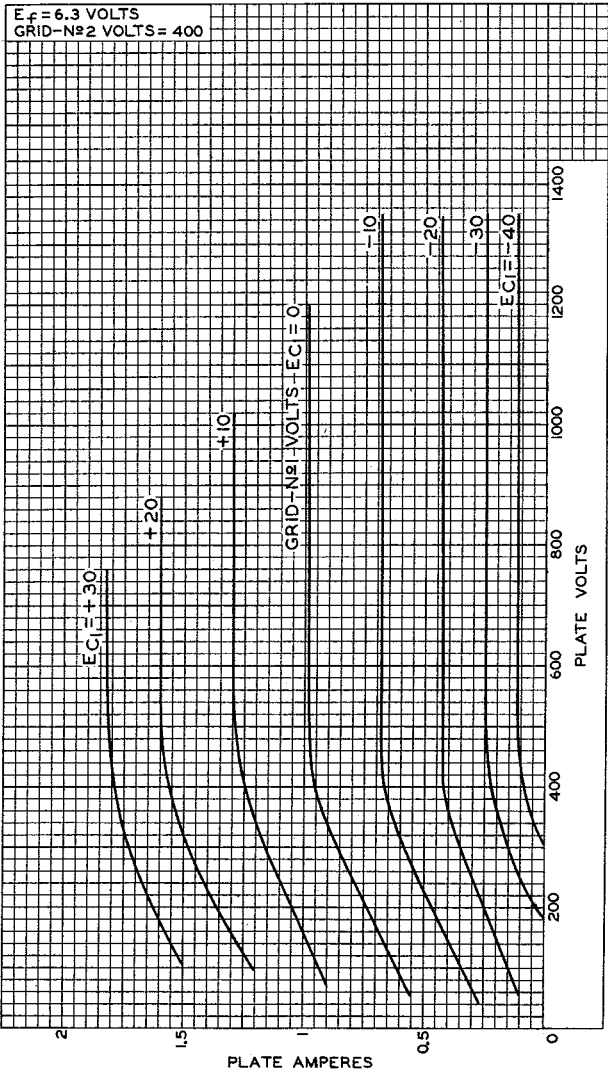

7270



7270

## TYPICAL CHARACTERISTICS

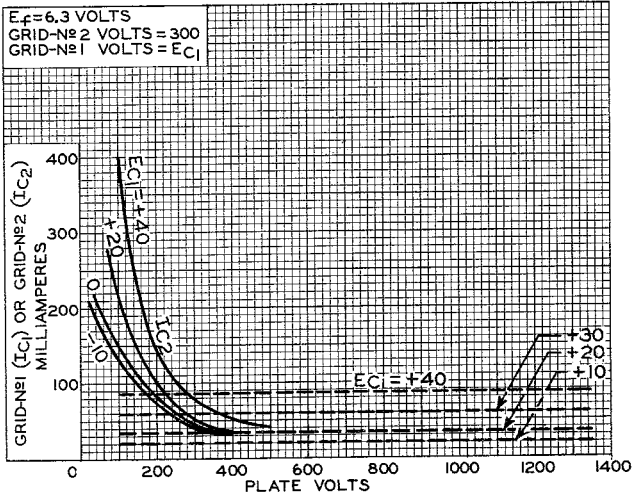

92CS-10158

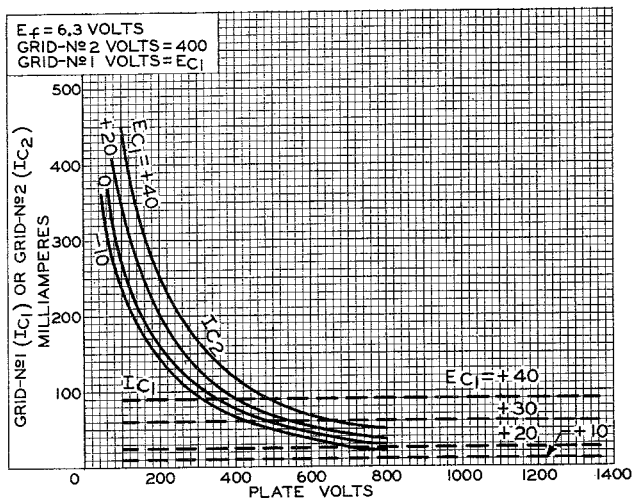

92CS-10171



7270

7270

### TYPICAL CONSTANT-CURRENT CHARACTERISTICS

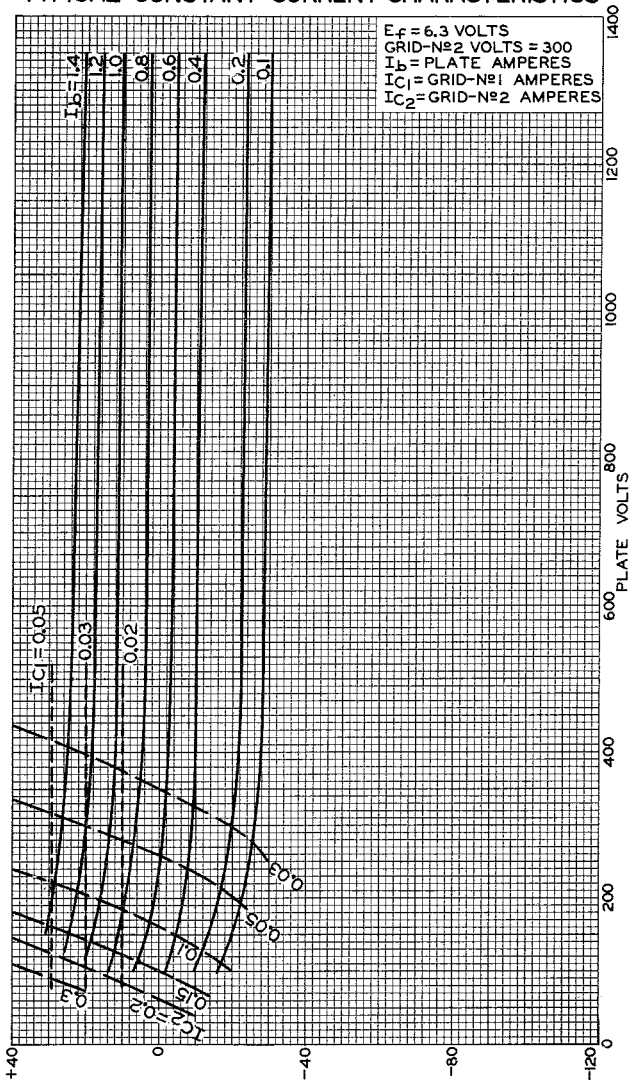

GRID-No. 1 VOLTS  
ELECTRON TUBE DIVISION

RADIO CORPORATION OF AMERICA, HARRISON, NEW JERSEY

92CM-10169

7270



7270

## TYPICAL CONSTANT-CURRENT CHARACTERISTICS

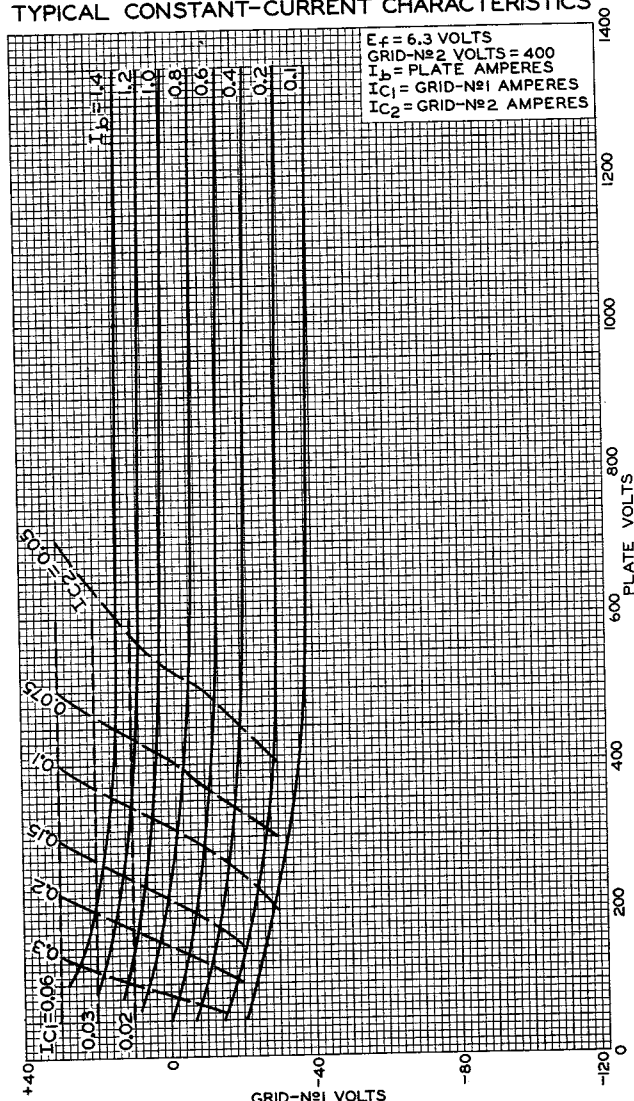
 ELECTRON TUBE DIVISION  
 RADIO CORPORATION OF AMERICA, HARRISON, NEW JERSEY

92CM-10176



### TYPICAL CHARACTERISTICS TRIODE CONNECTION

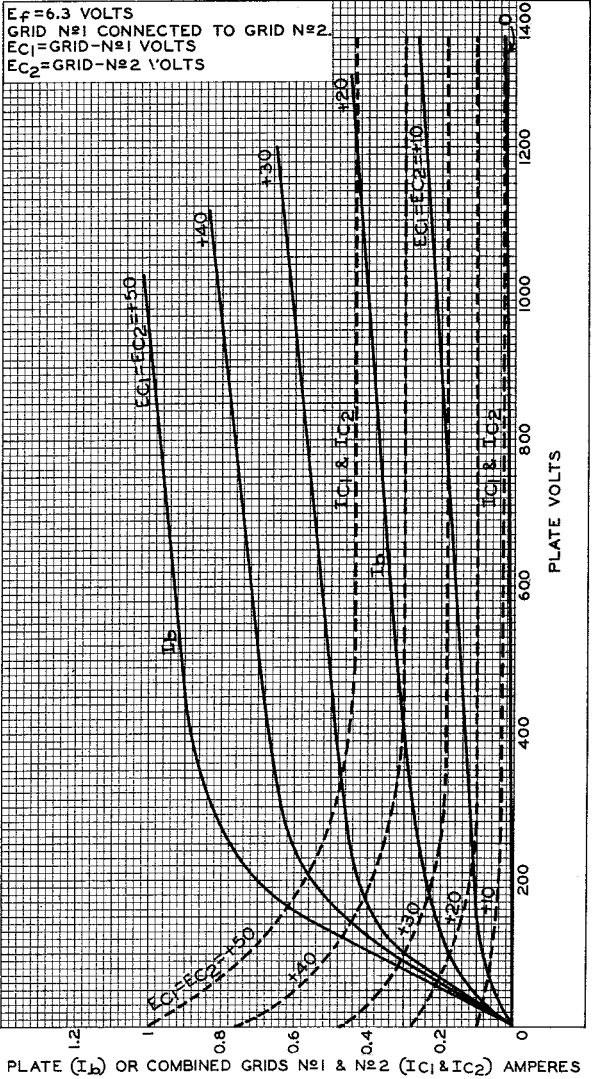

PLATE ( $I_b$ ) OR COMBINED GRIDS N $\circ$ 1 & N $\circ$ 2 ( $I_{C1}$  &  $I_{C2}$ ) AMPERES

ELECTRON TUBE DIVISION

92CM-10173RI

7270



7270

# TYPICAL CONSTANT-CURRENT CHARACTERISTICS TRIODE CONNECTION

$E_f = 6.3$  VOLTS  
 GRID N<sup>o</sup>1 CONNECTED TO GRID N<sup>o</sup>2.  
 $I_b$  = PLATE AMPERES  
 $I_{C1}$  &  $I_{C2}$  = COMBINED GRIDS N<sup>o</sup>1 &  
 N<sup>o</sup>2 AMPERES

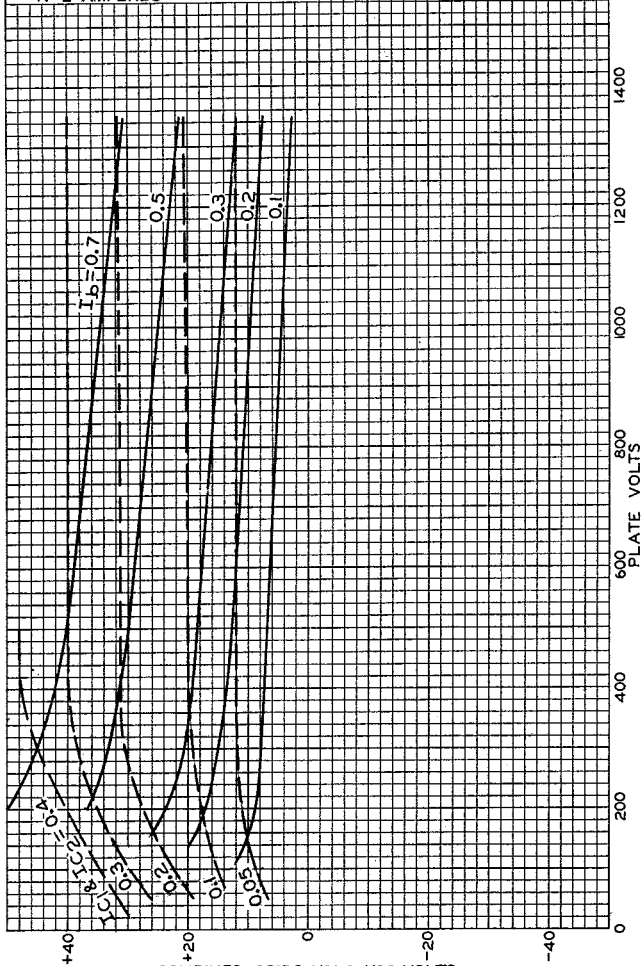
COMBINED GRIDS N<sup>o</sup>1 & N<sup>o</sup>2 VOLTS

ELECTRON TUBE DIVISION

RADIO CORPORATION OF AMERICA, HARRISON, NEW JERSEY

92CM-10178RI