



TECHNICAL DATA

7289
3CX100A5

PLANAR TRIODE

The EIMAC Type 7289/3CX100A5 is a rugged ceramic/metal planar triode designed for use in CW, grid- or plate-pulsed oscillator, amplifier or frequency multiplier service up to 3 GHz. The tube may also be used in pulse modulator or voltage regulator service. The 7289 is supplied with an air cooled radiator for forced air cooling.

The 7289 features high mu, high transconductance, great mechanical strength and low interelectrode capacitance.

Note: The data for the 7289/3CX100A5 also apply to the 2C39A and 2C39WA in all respects, except that filament voltage for 2C39A is 6.3 volts.



GENERAL CHARACTERISTICS¹

ELECTRICAL

Cathode: Oxide Coated, Unipotential

Heater: Voltage	6.0 ± 0.3 V
Current, at 6.0 volts	1.0 A
Transconductance (Average):	
I _b = 70 mA, E _b = 600 Vdc	25 mmhos
Amplification Factor (Average)	100
Direct Interelectrode Capacitance (grounded cathode) ²	
C _{in}	6.30 pF
C _{out}035 pF
C _{gp}	2.00 pF
Cut-off bias ³	-25 V max

1. Characteristics and operating values are based upon performance tests. These figures may change without notice as the result of additional data or product refinement. EIMAC Division of Varian should be consulted before using this information for final equipment design.
2. Capacitance values are for a cold tube as measured in a special shielded fixture. When the cathode is heated to the proper temperature, the grid-cathode capacitance will increase from the cold value by approximately 1 pF due to thermal expansion of the cathode.
3. Measured with one milliamperes plate current and a plate voltage of 1 kVdc.

(Revision 11-1-71) © by Varian

Printed in U.S.A.

MECHANICAL

Maximum Overall Dimensions

Length	2.701 in; 68.60 mm
Diameter	1.264 in; 32.11 mm
Net Weight	2.2 oz; 63 gm
Operating Position	Any
Maximum Operating Temperature:	
Ceramic/Metal Seals	250°C
Anode Core	250°C
Cooling	Forced Air
Terminals	Coaxial, special

ENVIRONMENTAL

Shock, 11 ms, non-operating	60 G
Vibration, operating, all axis, 55 to 500 Hz	10 G
Altitude, max (in suitably designed circuit)	60,000 ft.

RANGE VALUES FOR EQUIPMENT DESIGN

	<u>Min.</u>	<u>Max.</u>
Heater: Current at 6.0 volts	0.90	1.05 A
Cathode Warmup Time	60	--- sec.
Interelectrode Capacitance ¹ (grounded cathode connection)		
C _{in}	5.60	7.00 pF
C _{out}	---	0.95 pF
C _{gp}	1.95	2.15 pF

1. Capacitance values for a cold tube as measured in a special shielded fixture. When the cathode is heated to the proper temperature, the grid-cathode capacitance will increase from the cold value by approximately 1 pF due to thermal expansion of the cathode.

CW RF POWER AMPLIFIER OR OSCILLATOR

ABSOLUTE MAXIMUM RATINGS

DC PLATE VOLTAGE	1000 VOLTS
DC GRID VOLTAGE	-150 VOLTS
INSTANTANEOUS PEAK GRID-CATHODE VOLTAGE	
Grid negative to cathode	-400 VOLTS
Grid positive to cathode	30 VOLTS
DC PLATE CURRENT	100 MILLIAMPERES
DC GRID CURRENT	50 MILLIAMPERES
AVERAGE PLATE DISSIPATION	
Forced air cooling ¹	100 WATTS
GRID DISSIPATION (Average).	2 WATTS
FREQUENCY	2.5 GHz

1. Using EIMAC radiator PN 014224.

OPERATING CONDITIONS FOR 7289 IN REPRESENTATIVE APPLICATION

GROUNDING GRID CW POWER AMPLIFIER

Frequency	500 MHz
Heater Voltage	6.0 V
DC Plate Voltage	900 Vdc
DC Grid Voltage (approx.)	-40 Vdc
DC Cathode Current	90 mAdc
DC Grid Current	25 mAdc
Drive Power (approx.)	6 W
Useful CW Power Output	40 W

GROUNDING GRID CW OSCILLATOR

Frequency	2.5 GHz
Heater Voltage	5.0 V
DC Plate Voltage	900 Vdc
DC Grid Voltage (approx.)	-20 Vdc
DC Plate Current	90 mAdc
DC Grid Current	10 mAdc
Useful CW Power Output	17 W

GRID PULSED OR PLATE PULSED AMPLIFIER OR OSCILLATOR

ABSOLUTE MAXIMUM RATINGS

DC PLATE VOLTAGE (grid pulsed)	1000 VOLTS
PEAK PULSE PLATE VOLTAGE (plate pulsed)	3500 VOLTS
DC GRID VOLTAGE	-150 VOLTS
INSTANTANEOUS PEAK GRID-CATHODE VOLTAGE Grid negative to cathode	-700 VOLTS
Grid positive to cathode	250 VOLTS
PULSE PLATE CURRENT	3.0 AMPERES
PULSE GRID CURRENT	1.8 AMPERES
AVERAGE PLATE DISSIPATION Forced Air Cooling ¹	100 WATTS
GRID DISSIPATION (Average)	2 WATTS
FREQUENCY	3.0 GHz
PULSE DURATION ²	3 μ s
DUTY FACTOR ²0025

PULSE MODULATOR AND PULSE AMPLIFIER SERVICE

ABSOLUTE MAXIMUM RATINGS

DC PLATE VOLTAGE	1000 VOLTS
PEAK PLATE VOLTAGE	1200 VOLTS
DC GRID VOLTAGE	-150 VOLTS
INSTANTANEOUS PEAK GRID-CATHODE VOLTAGE Grid negative to cathode	-700 VOLTS
Grid positive to cathode	150 VOLTS
PULSE CATHODE CURRENT	4.8 AMPERES
DC PLATE CURRENT	100 MILLIAMPERES

Operating Conditions for 7289 in Representative Application.

PLATE PULSED OSCILLATOR

Frequency	3.0 GHz
Heater Voltage	5.8 V
Peak Plate Voltage	3500 v
Peak Video Plate Current	3.0 a
Peak Video Grid Current	1.8 a
Useful Power output (approx.)	1600 w
Pulse Duration	3 μ s
Duty Factor0025

1. Using EIMAC radiator PN 014224.
2. For applications using longer pulse duration and/or higher duty cycle consult the nearest Varian Electron Tube & Device Field Office, or the Product Manager, EIMAC Division of Varian, Salt Lake City, Utah.

AVERAGE PLATE DISSIPATION

Forced Air Cooling ¹	100 WATTS
GRID DISSIPATION (Average)	2 WATTS
PULSE DURATION ²	3.0 μ s
CUT-OFF μ	70
DUTY FACTOR0025

1. Using EIMAC radiator PN 014224.
2. For applications using longer pulse duration and/or higher duty cycle consult the nearest Varian Electron Tube & Device Field Office, or the Product Manager, EIMAC Division of Varian, Salt Lake City, Utah.

APPLICATION

For general application information please refer to the Planar Triode Operating Instruction Sheet. The operating instructions should be consulted prior to the designing of new requirements around the above tube type. Plate dissipation of up to 150 watts is possible with the 7289 tube type when using radiator P/N 158555. If this is re-

quired the tube order should include reference to the different radiator part number. For unusual and special application consult the nearest Varian Electron Tube and Device Field Office, or the Product Manager, EIMAC Division of Varian, Salt Lake City, Utah.

AIRFLOW vs STATIC PRESSURE WITH
STANDARD COWLING JAN-157

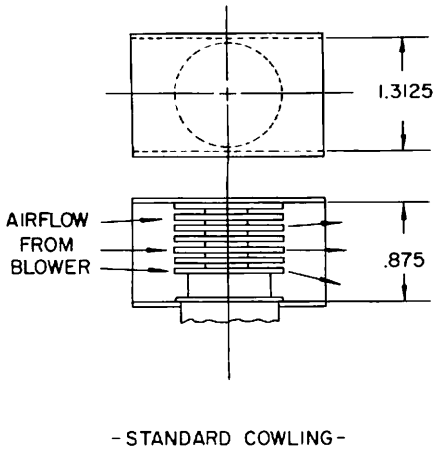

MAXIMUM PLATE DISSIPATION vs COOLING AIRFLOW

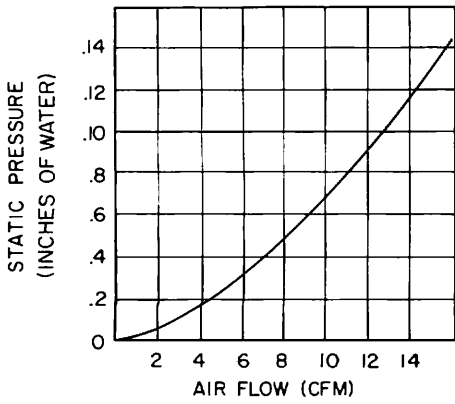
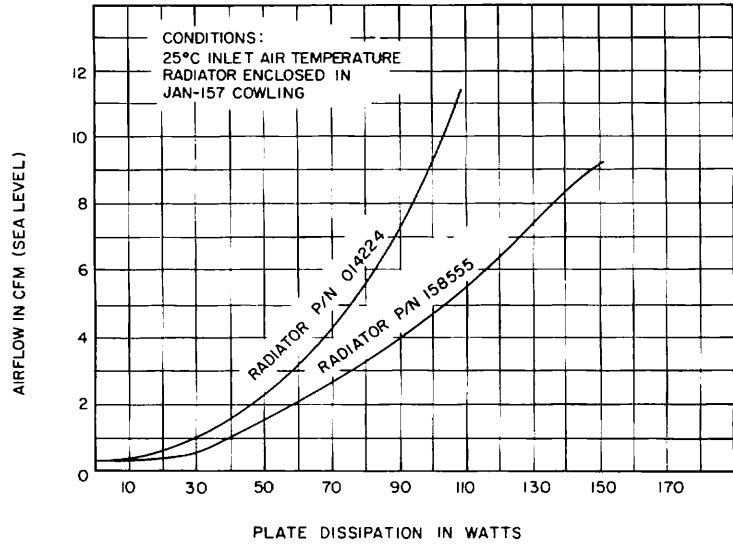

COMBINED CORRECTION FACTORS FOR INLET AIR TEMPERATURE
AND ALTITUDE
(RELATIVE TO 25°C AND SEA LEVEL)

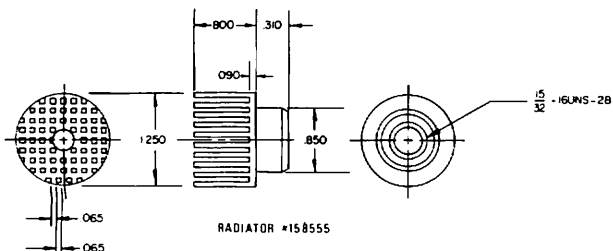
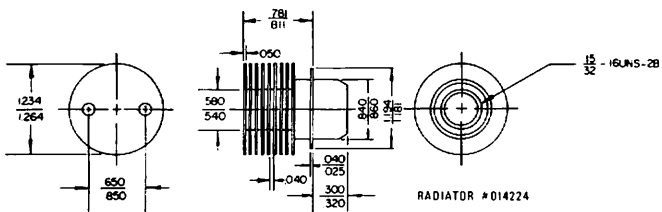
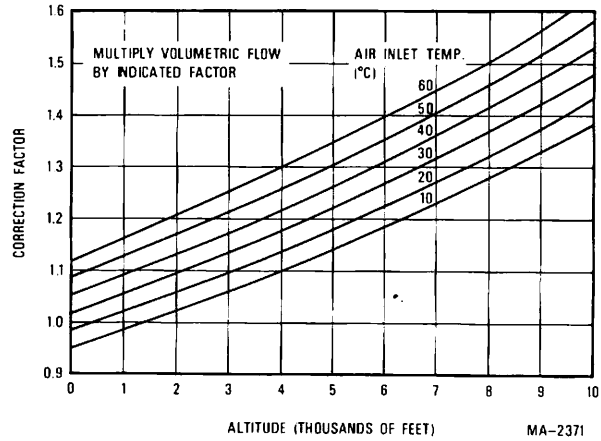

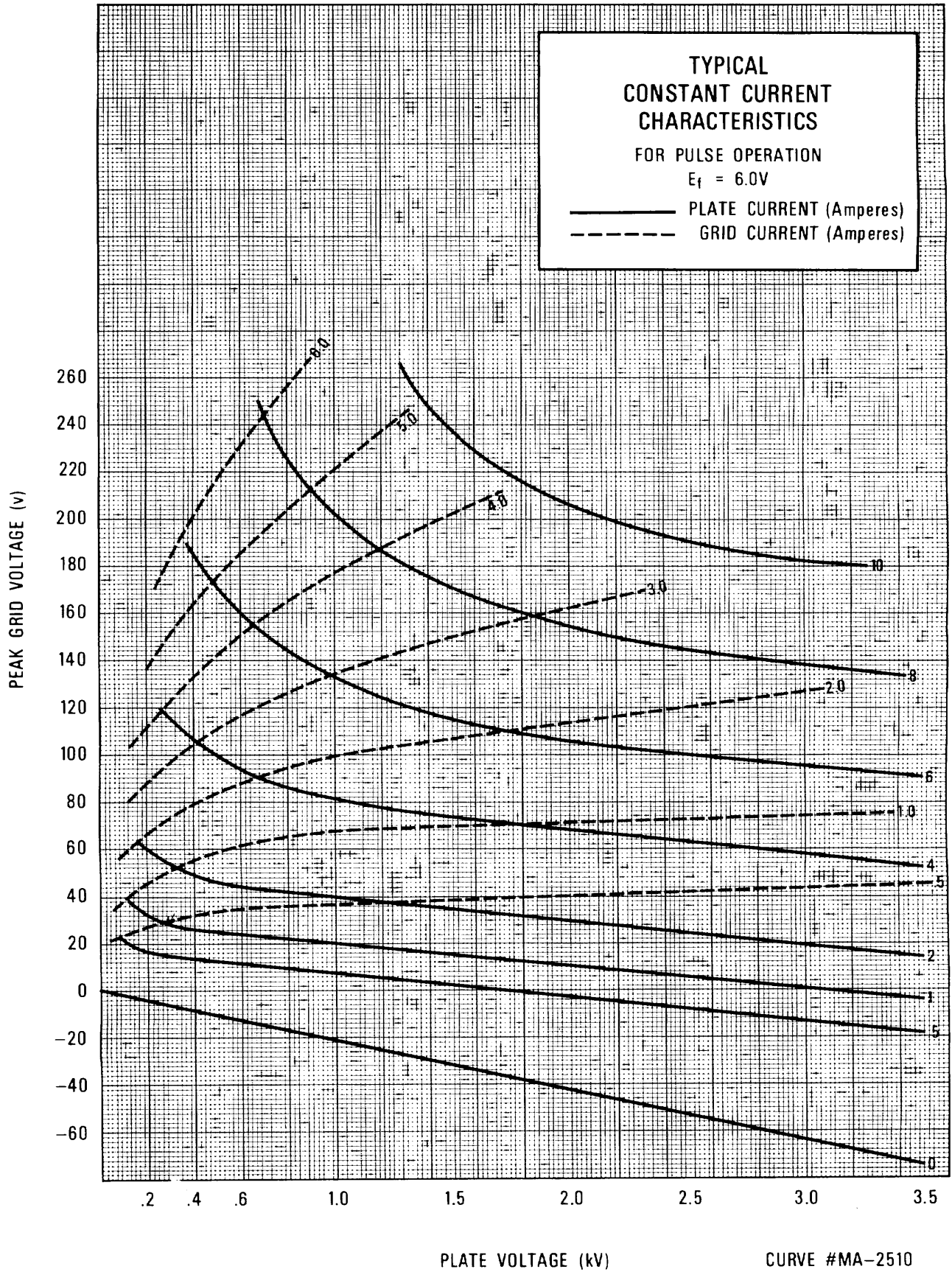

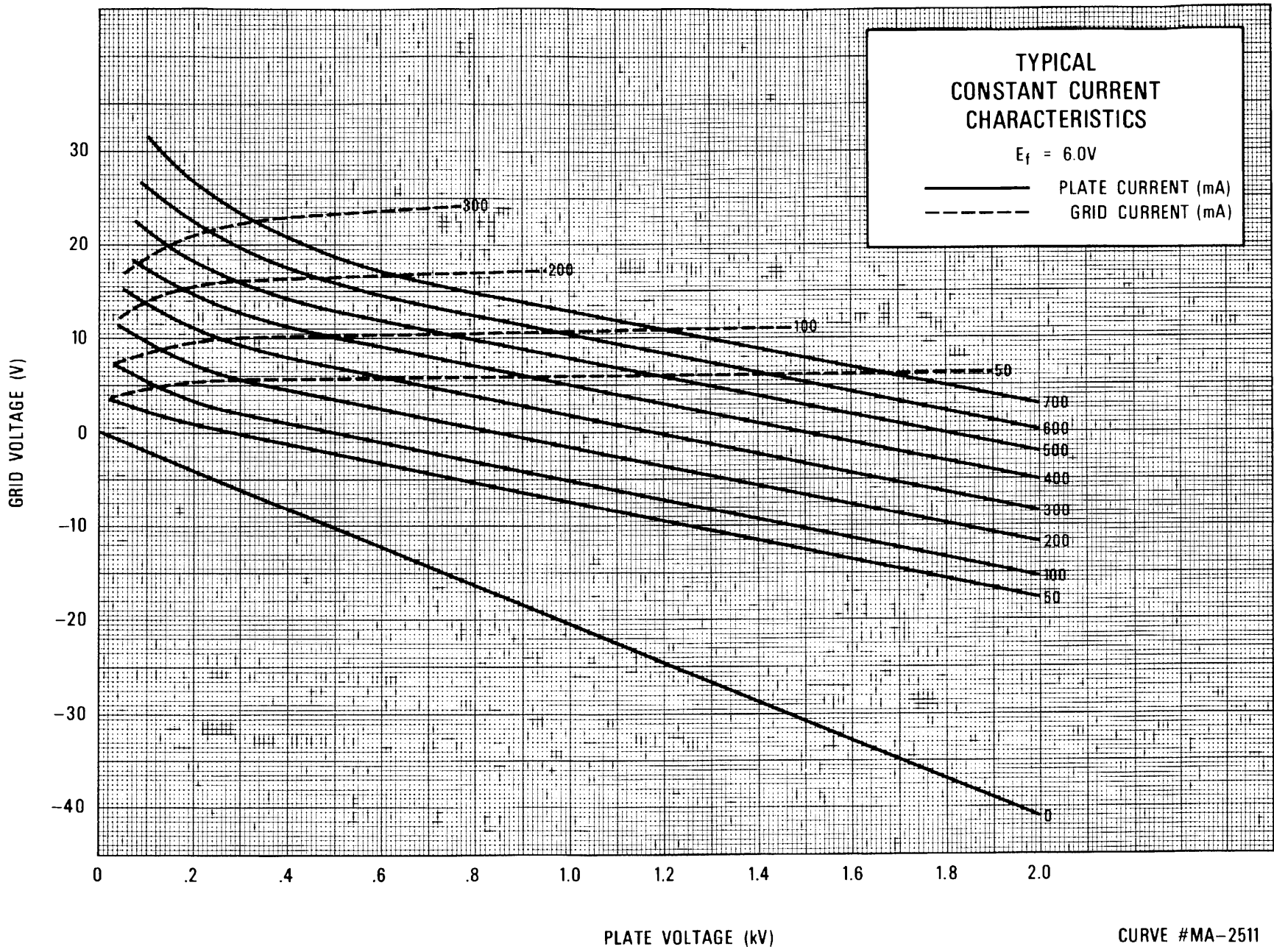

CURVE #MA-2511

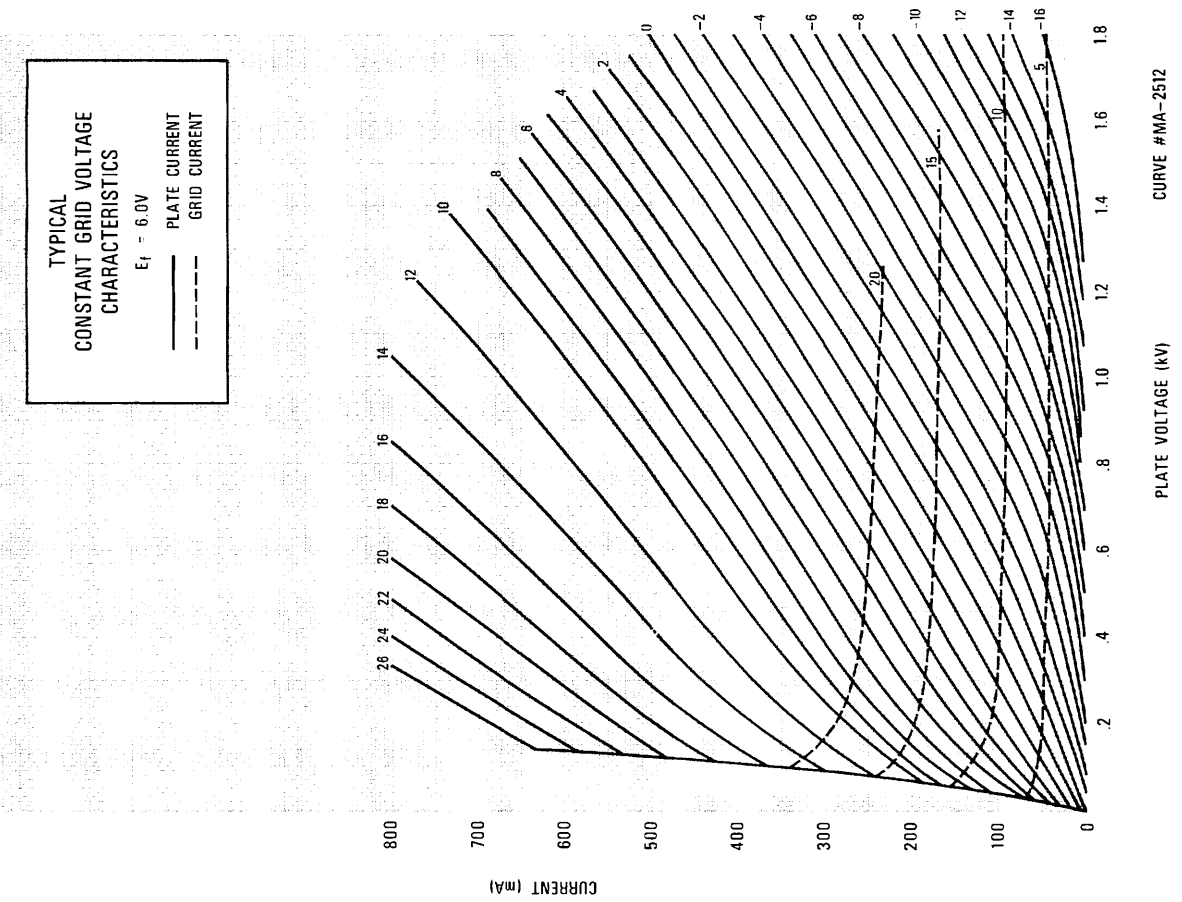
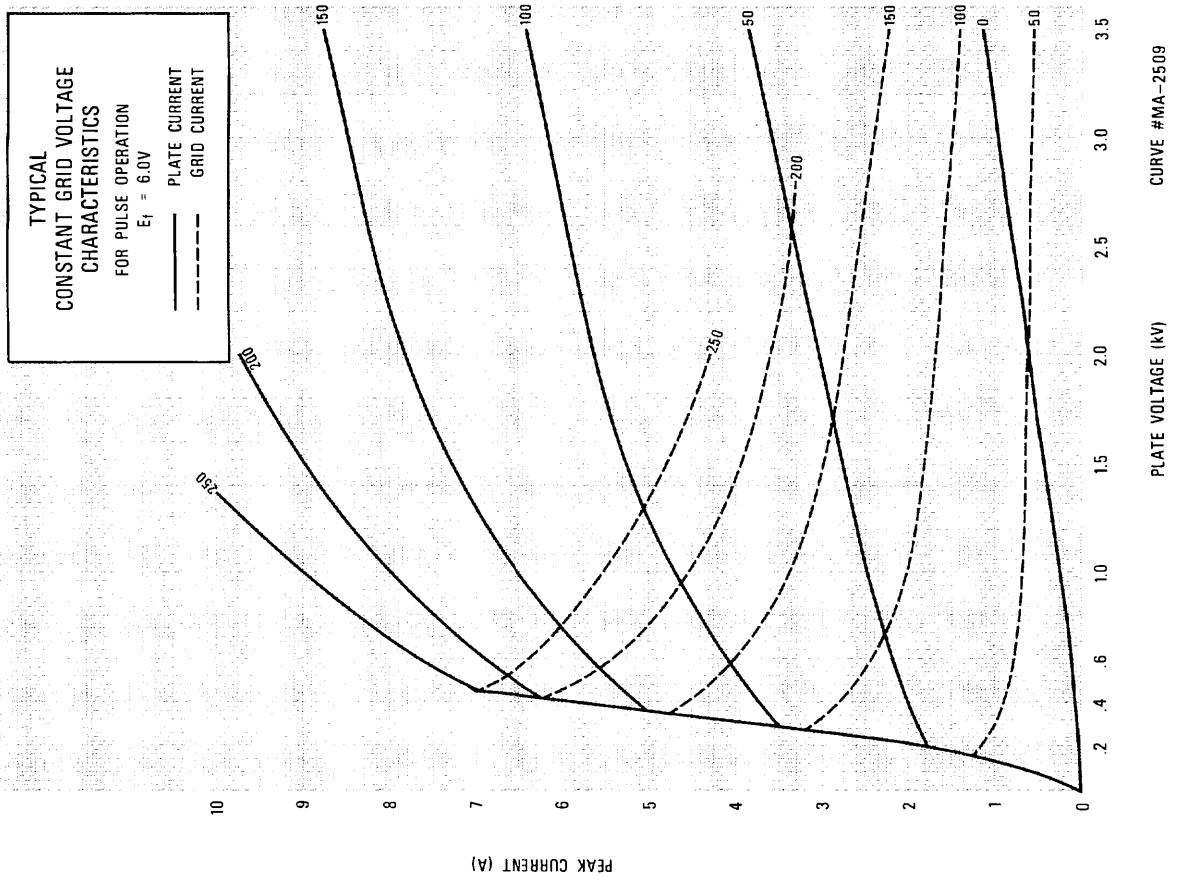

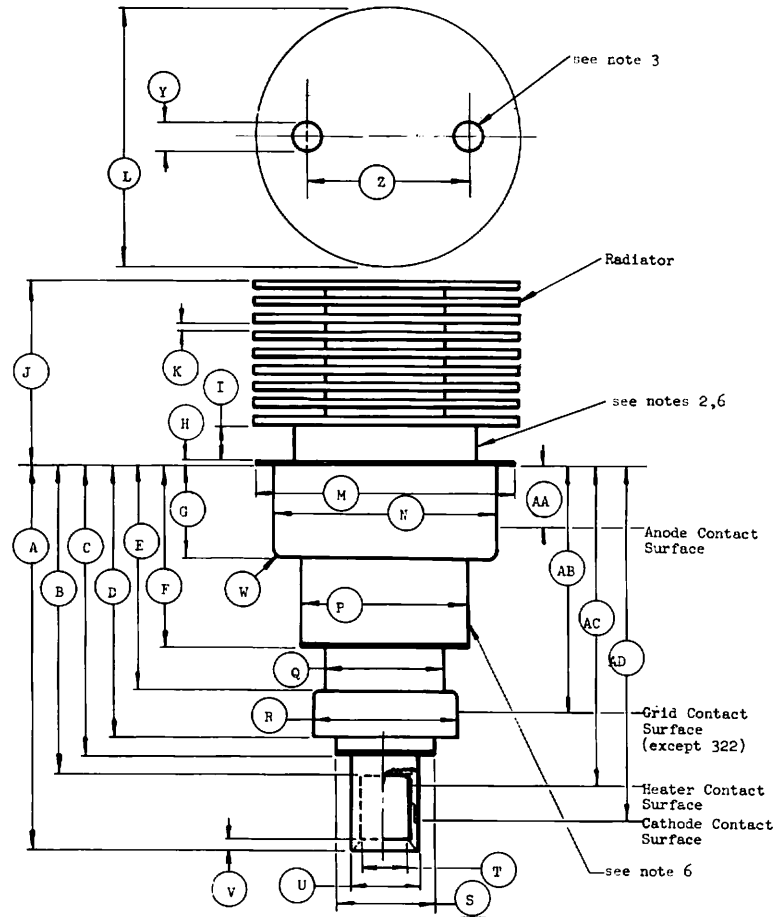

ELECTRODE CONTACT AREA				DIMENSIONAL DATA							
Dim. in Inches		Dim. in Millim.		Dim. in Inches		Dim. in Millimeters					
Min.	Max.	Min.	Max.	Min.	Max.	Ref.	Dim.	MIN.	MAX.	Ref.	
.035	.361	AA	.89	9.17	1.815	1.875	A	46.10	47.62		
1.185	1.265	AB	30.10	32.14		1.534	B		38.96		
1.534	1.728	AC	38.96	43.89		1.475	C		37.46		
1.475	1.815	AD	37.47	46.10	1.289	1.329	D	32.74	33.76		
					1.085	1.135	E	27.56	28.83		
					.880	.920	F	22.35	23.31		
					.462	.477	G	11.73	12.12		
						.040	H		1.02		
					.125	.185	I	3.18	4.70		
					.766	.826	J	19.46	20.98		
					.025	.046	K	.64	1.17		
					1.234	1.264	L	31.34	32.11		
					1.180	1.195	M	29.97	30.35		
					1.025	1.035	N	26.04	26.29		
					.752	.792	P	19.20	20.12		
					.541	.561	Q	13.74	14.25		
					.655	.665	R	16.64	16.89		
					.545		S		13.84		
					.213	.223	T	5.41	5.66		
					.315	.325	U	8.00	8.26		
					.100		W		2.54		
					.105	.145	Y	2.67	3.68		
					.650	.850	Z	16.51	21.59		
						.086	V		2.18		

- NOTES:
- Metric equivalents to the nearest .01 mm, are given for general information only & are based on 1 inch = 25.4 mm.
 - This surface shall be used to measure Anode shank temperature.
 - Holes for extractor thru top fin only.
 - Eccentricity of contact surfaces shall be gaged from center line of reference & shall be as follows:

Contact Surface	TIR Max.	Reference
Anode	.020	Cathode
Grid	.020	Cathode
Heater	.012	Cathode
 - Dias. N,R,T & U shall apply throughout entire length as defined by dims. AA,AB,AC & AD respectively.
 - This surface shall not be used for clamping or locating.
 - Electrode Contact dims. are given for socket design purposes & are not intended for inspection purposes.