



THOMSON-CSF

GRUPEMENT TUBES ELECTRONIQUES

DATA TEV 3097

TH 9807PA

September 1971 - Page 1/8

TH 9807 PA 1" VIDICON

- MAGNETIC FOCUS AND DEFLECTION
- HIGH RESOLUTION (1000 TV lines)
 - NORMAL SENSITIVITY
- EXCELLENT IMAGE UNIFORMITY
 - LOW LAG
- TELECINE AND BROADCAST TV

TH 9807PA is a 1" Vidicon designed especially for pick-up in high quality TV cameras (black and white or color TV cameras). This tube incorporates in its structure the latest isolated post-acceleration electrode with separate mesh connection. Due to this feature TH 9807PA provides higher resolution, higher output signal capability and better resolution and signal uniformity than previous Vidicon tubes.

TH 9807PA Vidicon is intended for Telecine and slides T.V. cameras. This tube can operate at high output signal and low target voltage without impairing the quality of image.

The maximum sensitivity of TH 9807PA can be equivalent to photographic film having an ASA exposure index of 200 to 1000 (adjustable by target voltage). In Telecine applications, for a normally encountered faceplate illumination of 10 to 100 lux (1 to 10 fc) TH 9807PA provides an output signal of 150 to 400 nA at 10 nA dark current approximately. In these conditions, excellent quality of image is obtained (resolution, signal to noise ratio, signal uniformity). For lower level illuminations the same output current can be maintained with a slightly higher dark current value.

Due to a new low lag photoconductive layer excellent quality of picture can be obtained within a large illumination range with good signal uniformity and appropriate "gamma" characteristics.

TH 9807PA performances are substantially identical under high or low level illumination conditions. Tubes sensitivity can be controlled by target voltage which also causes some variation of dark current within a narrow range.

TH 9807PA can be operated over a wide range of electrode voltage selection although recommended adjustment requires a g_4 voltage to g_3 voltage ratio of 1.4 - 1.5. Under these conditions TH 9807PA can provide an optimum resolution and an uniform signal output over the entire scanned area with a beam landing considerably improved minimizing "porthole" effect and geometrical distortion.

The limiting resolution of TH 9807PA is about 1000 T.V. lines at center of picture and 600 T.V. lines at corner. This high resolution is obtained with 900 V on electrode g_4 and 600 V on g_3 . When the TH 9807PA is operated at a lower g_4 voltage of 500 V and g_3 voltage of 330 V, its limiting resolution will be 900 T.V. lines at center and 500 T.V. lines at corner. Operating g_4 voltage at 1.5 times g_3 voltage requires 20 % deflection current increase over current necessary for $g_3 - g_4$ connected mode. Focusing field is not noticeably changed with such an operation.





Full advantage of resolution and signal uniformity is achieved when deflecting and focusing components are properly designed and when the tube is correctly located inside. The thickness of the photoconductive layer is made very uniform and allows for constant output signal and constant dark current. When landing error due to imperfect scanning system is present, the voltage gradient across the photoconductive layer is not uniform and a signal variation (shading) is introduced which can be compensated by proper adjustment of the cathode, g1 and g2 voltages.

Due to good design, high reliability is obtained all along tube life. Requirement alignment field is reduced to a minimum by precise electron gun mounting. An extremely flat faceplate avoids all optical distortions and allows for the use of any good quality lens. Particle barriers adjacent to the field mesh allows these tubes to operate in any position.

One watt power heater makes these Vidicons particularly suitable for transistorized equipment. The reduced heat dissipation improves the quality of the picture by lowering faceplate temperature.

GENERAL CHARACTERISTICS

Electrical

Heater		for unipotential cathode indirectly heated
Heater :		
- Voltage	6.3 ± 10 %	V
- Current at 6.3 V	0.15	A
Minimum preheating time	60	s
Output capacitances :		
- Target to all other electrodes	4.5	pF
Spectral response	see curve	
Focusing method	magnetic	
Deflection method	magnetic	

Mechanical

Base (Ditetrar, 8 pins)		UTE 9 C 15 (JEDEC N° E8 - 11)
Socket	note 1	METOX N° 30.250
Deflecting yoke - Focusing coil Assembly	note 2	GERHARD type BV 200-1K1
Alignment coil	note 2	GERHARD type BV 80/3
Dimensions		see drawing
Photoconductive layer :		
- normal dimensions of image on target		12.7 mm x 9.5 mm
- maximum useful diagonal diameter (4 x 3 aspect ratio) ..		17 mm
- orientation of quality rectangle :		
horizontal scan parallel to the plane passing through the tube axis and short index pin	note 3	
Maximum temperature of faceplate	70	°C
Mounting position	any	
Net weight, approximate	60	g



OPERATING CONDITIONS

Scanned area 12.7 mm x 9.5 mm

Maximum ratings

Electrode g4 voltage (post-acceleration electrode)	1000	V
Electrode g3 voltage (wall electrode)	1000	V
Electrode g2 voltage (accelerator)	350	V
Electrode g1 voltage (electrode for picture cut-off)		
- negative bias value	150	V
- positive bias value	0	V
Peak heater-cathode voltage :		
- heater negative with respect to cathode	125	V
- heater positive with respect to cathode	10	V
Target voltage	125	V
Dark current	0.20	μ A
Peak target current (note 4)	0.60	μ A
Faceplate :		
- Illumination	10000	lux
- Temperature	or 1000	fc
	70	$^{\circ}$ C

Typical operation

Scanned area 12.7 mm x 9.5 mm
Faceplate temperature 25 $^{\circ}$ C (note 5)

<i>Electrode voltage modes :</i>	Intermediate	High	
Electrode g4 voltage	500	900	V
Electrode g3 voltage	330	600	V
Electrode g2 voltage	300	300	V
Electrode g1 (note 6)	-45 to -110	-45 to -110	V
Average "gamma" for a target illumination between 1 and 100 lux (note 7)	0.65	0.65	
Minimum blanking peak to peak voltage :			
- applied to electrode g1	-75	-75	V
- applied to cathode	+20	+20	V
Limiting resolution at center of picture (note 8)	900	1000	TV lines
Limiting resolution at corner of picture	500	600	TV lines
M.T.F. response at 400 TV lines at center of picture (5 MHz - 625 CCIR standard) (note 9)	40	50	%
Field strength at center of focusing coil	40 \pm 2	50 \pm 2	Gauss
Peak deflecting coil current :			
- horizontal	170	200	mA
- vertical	20	24	mA
Field strength of alignment coil	0 to 4	0 to 4	Gauss



1 - HIGH LIGHT LEVEL OPERATION

(faceplate illumination 100 lux or 10 fc)

Dark current i_0	5	nA
Target voltage for $i_0 = 5$ nA (note 10)	10 to 25	V
Faceplate illumination (2854 °K) (note 11)	100	lux
	or 10	fc
Signal current	300	nA
Lag : (note 12)		
- maximum	15	%
- average	10	%

2 - AVERAGE SENSITIVITY OPERATION

(faceplate illumination 10 lux or 1 fc)

Dark current i_0	20	nA
Target voltage for $i_0 = 20$ nA (note 10)	20 to 50	V
Faceplate illumination (2854 °K) (note 11)	10	lux
	or 1	fc
Signal current	180	nA
Corresponding sensitivity	150	μ A/lm
Target illumination for 100 nA signal current	3	lux
	or 300	mfc
Lag : (note 12)		
- maximum	20	%
- average	12	%

3 - HIGH SENSITIVITY OPERATION

(faceplate illumination 5 lux or 500 mfc)

Dark current i_0	50	nA
Target voltage for $i_0 = 50$ nA (note 10)	25 to 60	V
Faceplate illumination (2854 °K) (note 11)	500	mfc
Signal current	200	nA
Corresponding sensitivity	350	μ A/lm
Target illumination for 100 nA signal current	1.5	lux
	or 150	mfc
Lag : (note 12)		
- maximum	20	%
- average	15	%

4 - SPURIOUS SIGNAL TEST

The test is performed using a uniformly diffused white test pattern that is separated into two zones as shown in drawing :

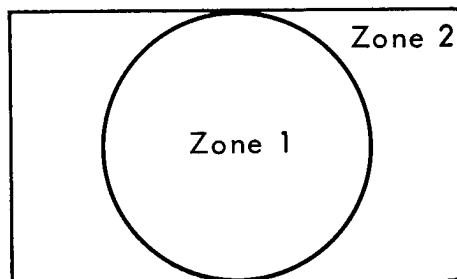



The tube is operated under the "Typical Operation" conditions with a dark current of 20 nanoamperes and the lens adjusted to provide a signal current of 400 nanoamperes.

Spurious signals are classified by their size which is measured by percent of raster height.

Will actually be considered as a defect, a spot blemish (black or white spot) having a contrast ratio greater than 25 %. (note 13)

Allowable spot size for each zone is shown in table :

Ratio D/H* (percent raster height)	Number allowed	
	Zone 1	Zone 2
D/H ≥ 0,4 %	0	0
D/H < 0,4 %	0	4

* D : average diameter of spot
H : raster height

The picture must be of a very imperceptible mottled or grainy appearance with no streaks of large area.

NOTES

- 1 - METOX - 86, rue de Villiers de l'isle Adam - PARIS 20ème.
Telephone : 636 - 31 -10
- 2 - GERHARD KG - REICHELSEIM / ODW Germany
- 3 - It is necessary to assure correct positioning of the tube inside the coils. An immediate test consists in observing the fine mesh grid, the wires of which should be inclined 45° with respect to scanning. Then again the front end of the deflecting yoke should be positioned at 20 mm from the tube faceplate.
- 4 - Target current is defined as total current in load resistance connected to target electrode : signal current plus dark current, dark current being the current left when illumination is subtracted.
Video amplifiers must be designed properly to handle peak target current of 0.6 μA to avoid amplifier overload and picture distortion.
- 5 - All these characteristics are provided for a temperature of faceplate of 25 °C, the temperature range recommended is within 20 to 30 °C. The rise of faceplate temperature is a function of ambient temperature, thermic dissipation of ambient devices and of the tube itself. Consequently, 10 °C of faceplate temperature rise implies a dark current multiplied by a factor of 2.
- 6 - Without blanking pulses applied on electrode g1.
- 7 - Average "gamma" should be defined as the slope of the rectilinear part of transfer characteristics in log coordinates.
- 8 - Practically, limiting resolution corresponds to the resolution measured with twin bar test card with a modulation ratio of about 7 %.
- 9 - For 625 lines C.C.I.R. standard, line duration being 52 μs (line suppression period not included), 400 TV lines correspond to 5 MHz.
- 10 - Indicated range of each type of service serves only to illustrate the operating target voltage range normally encountered. the target voltage for each Vidicon must be adjusted to that value which gives the designed operating dark current.
- 11 - All the above mentionned illumination assume 2854°K incandescent tungsten source.
- 12 - Lag is defined as the ratio of residual signal current measured 60 milliseconds after light excitation being removed to the initial signal current ; this value assumes 50 field/second scanning rate.
- 13 - Contrast is defined as : $100 \times \frac{\text{increment in video current due to the blemish}}{\text{normal signal current}}$



Figure 1

TYPICAL SPECTRAL SENSITIVITY CHARACTERISTICS

For equal values of signal current at all wavelengths
(0.02 μA signal current and 0.02 μA dark current
for scanned area of 12.7 x 9.5 mm)

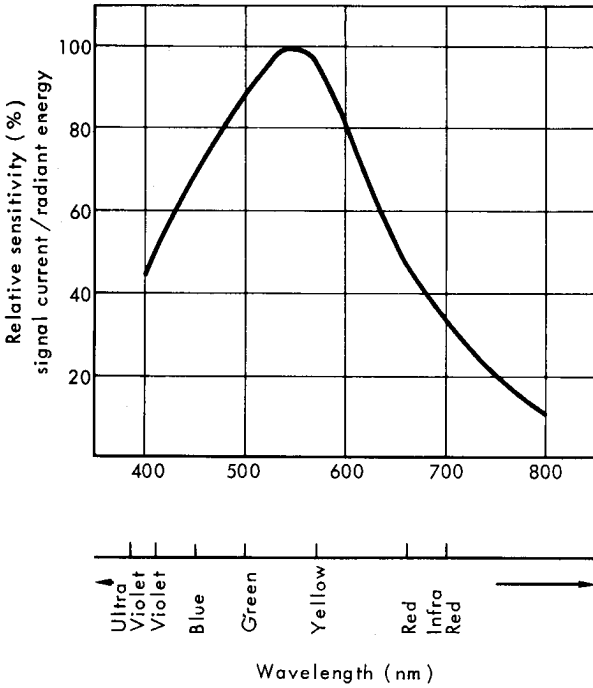

Figure 2

LIGHT TRANSFER CHARACTERISTICS

Illumination uniform over photoconductive layer scanned
area 12.7 x 9.5 mm-face plate temperature 25°C

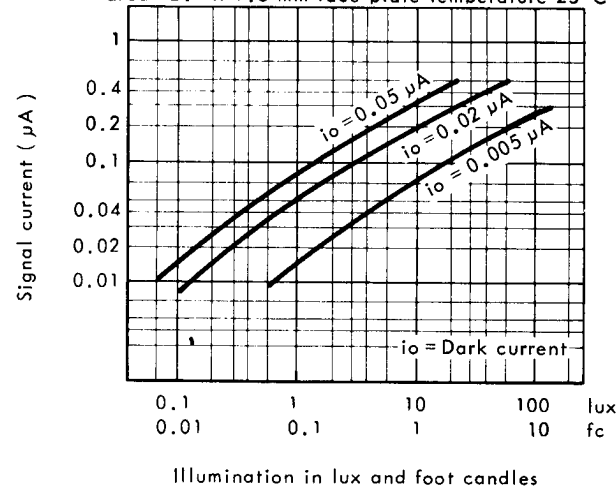

Figure 3

MODULATION TRANSFER FUNCTION

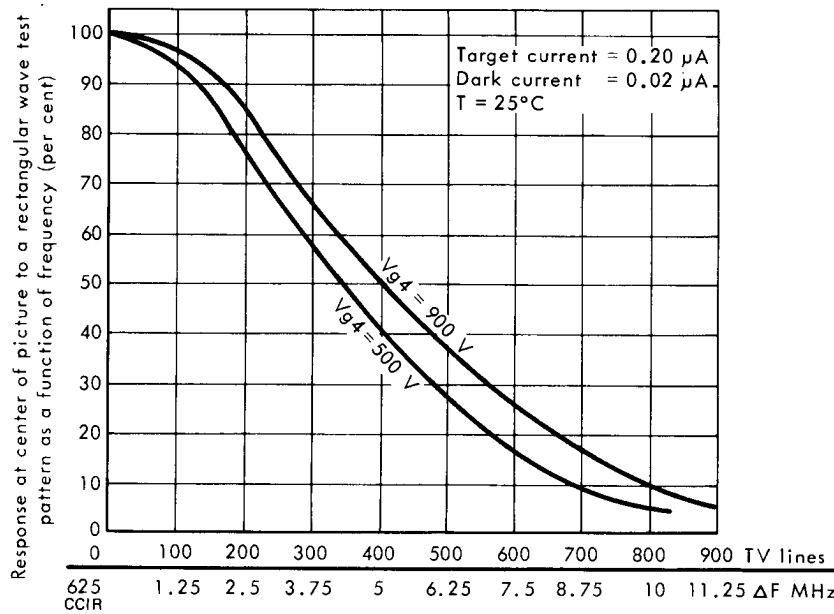



Figure 4

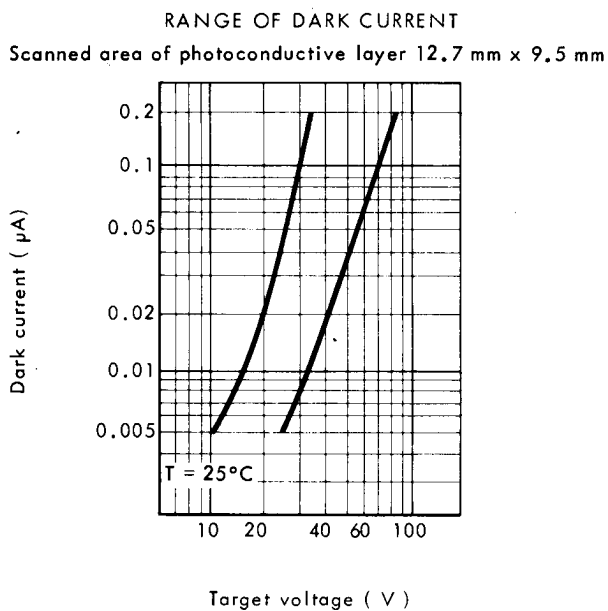

Figure 5

TYPICAL PERSISTENCE CHARACTERISTICS
Initial highlight signal current of $0.2 \mu\text{A}$ scanned area of photoconductive layer $12.7 \times 9.5 \text{ mm}$

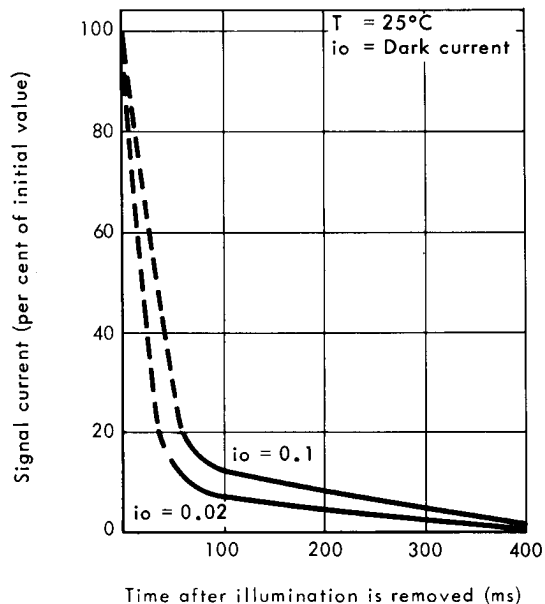
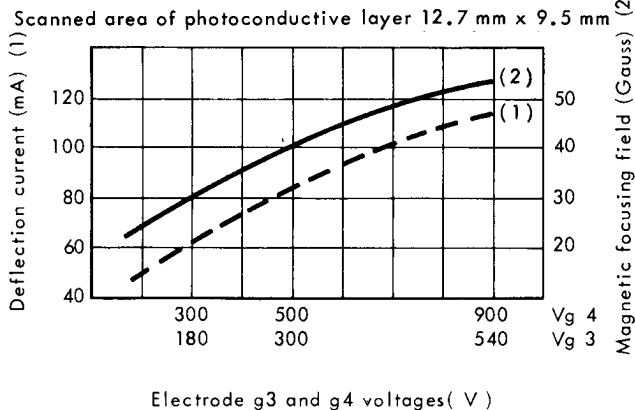

Figure 6

- (1) Deflection current as a function of electrode g3 and g4 voltages ($V_{g3} = 0.6 V_{g4}$)
- (2) Magnetic field at center of focusing coil ($V_{g3} = 0.6 V_{g4}$)





OUTLINE DRAWING

UTE 9C15 base
(JEDEC E8-11)

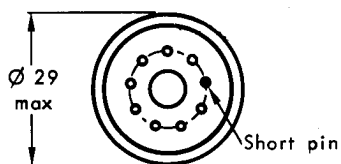

BASING DIAGRAM

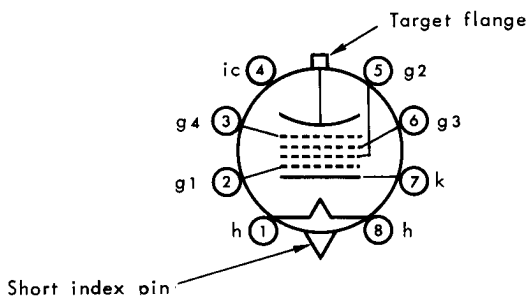

1 - Heater	5 - Electrode g2
2 - Electrode g1	6 - Electrode g3
3 - Electrode g4	7 - Cathode
4 - Internal connection	8 - Heater

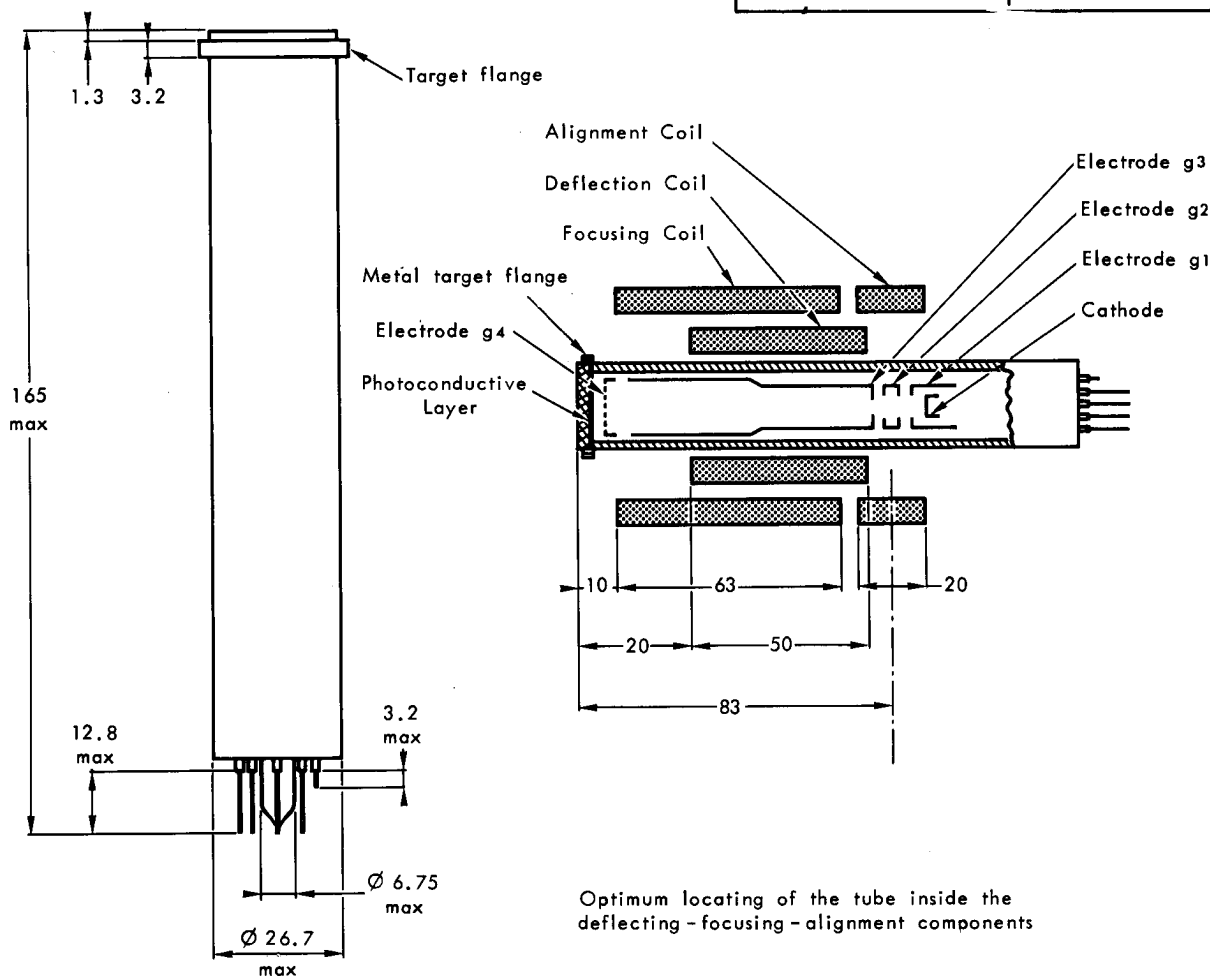

Optimum locating of the tube inside the deflecting - focusing - alignment components

Dimensions in mm.

