



# TECHNICAL DATA

**3CX800A7  
HIGH - MU  
POWER TRIODE**

The EIMAC 3CX800A7 is a compact power triode intended for use as a cathode-driven Class AB2 or Class B amplifier in rf applications including the VHF band. As a linear amplifier, high power gain may be obtained without sacrifice of low intermodulation distortion characteristics. Low grid interception and high amplification factor combine to make the 3CX800A7 drive power low for a tube of this power capacity. A single 3CX800A7 will deliver 750 watts PEP and 750 watts key-down CW output power to 350 MHz. The 3CX800A7 is useful to 600 MHz. (For typical cavity operation see page 10) A pulse rated version (3CPX800A7) is also available.

The anode is forced-air cooled for 800 watts of dissipation.

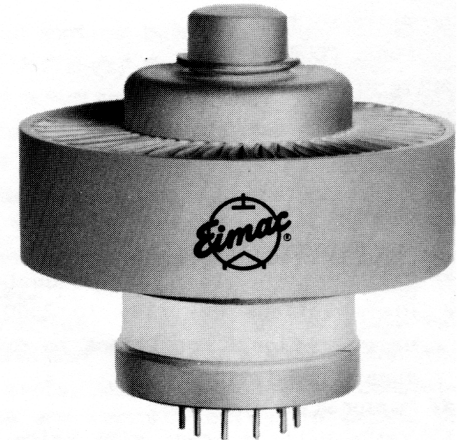

## GENERAL CHARACTERISTICS<sup>1</sup>

### ELECTRICAL

Cathode: Oxide Coated, Unipotential

Heater Voltage . . . . .	13.5 ± 0.6 V
Heater Current, at 13.5 volts . . . . .	1.5 A
Cathode-Heater Potential (maximum) . . . . .	+ 150 V
Minimum Warmup Time (before application of rf drive and high voltage) . . . . .	3 Min
Amplification Factor (approximate) . . . . . <sup>2</sup>	200
Direct Interelectrode Capacitance (grid grounded)	
C <sub>in</sub> . . . . .	26.0 pF
C <sub>out</sub> . . . . .	6.1 pF
C <sub>pk</sub> . . . . .	0.05 pF
Highest Frequency for Maximum Ratings . . . . .	350 MHz

1. Characteristics and operating values are based on performance tests. These figures may change without notice as the result of additional data or product refinement. Varian EIMAC should be consulted before using this information for final equipment design.
2. Capacitance values are for a cold tube as measured in a special shielded fixture in accordance with Electronic Industries Association Standard RS-191.

### MECHANICAL

Maximum Overall Dimensions

Length . . . . .	2.52 in; 64.01 mm
Diameter . . . . .	2.53 in; 64.26 mm
Net Weight . . . . .	11.5 oz; 326 gm
Operating Position . . . . .	Any
Cooling . . . . .	Forced Air

Maximum Operating Temperature:

Ceramic/Metal Seals or Anode Core . . . . .	250°C
Base . . . . .	Large Wafer Elevenar 11-Pin with Ring (EIA No. E11-81)
Recommended Socket . . . . .	EIMAC SK-1900
Recommended Air Chimney . . . . .	EIMAC SK-1906
Available Chimney Clamp for SK-1906 (needed if mounting is not vertical, anode up)	EIMAC SK-1916
Available Grid Collet with grounding flange to fit SK-1900 (for VHF operation) . . . . .	EIMAC P/N 720359
Available Grid Bypass Capacitor Ring (1100 pF @ 1000 DCWV) . . . . .	EIMAC SK-655
Available Anode Connector Clip . . . . .	EIMAC ACC-1

VA5131 (Effective August 1989, Supersedes April 1987)

Printed in U.S.A.

**RADIO FREQUENCY LINEAR AMPLIFIER**  
**CATHODE DRIVEN Class AB2**
**TYPICAL OPERATION - Measured Data (to 150 MHz)**  
**Class AB2 Cathode Driven**
**ABSOLUTE MAXIMUM RATINGS (to 350 MHz):**

DC PLATE VOLTAGE # . . . . .	2250	VOLTS
DC PLATE CURRENT . . . . .	0.6	AMPERE
PLATE DISSIPATION . . . . .	800	WATTS
GRID CURRENT . . . . .	0.06	AMPERE
GRID DISSIPATION . . . . .	4.0	WATTS

	<u>CW/SSB</u>	
Plate Voltage . . . . .	2200	Vdc
Cathode Bias Voltage . . . . .	+8.2	Vdc
Zero-Signal Plate Current * . . . .	15	mAdc
CW Plate Current . . . . .	500	mAdc
CW Power Input . . . . .	1100	W
Peak Envelope Power Input . . . . .	1100	w
Two-Tone Plate Current § . . . . .	313	mAdc
CW Grid Current * . . . . .	36	mAdc
Two-Tone Grid Current * § . . . . .	16	mAdc
Peak rf Cathode Voltage * . . . . .	64	v
Peak Driving Power * . . . . .	23	w
Useful Power Output ## . . . . .	750	W
Useful Power Output, PEP ## . . . .	750	w
Cathode Input Impedance . . . . .	54	Ohms
Resonant Load Impedance . . . . .	2700	Ohms
Intermodulation Distortion **		
3rd Order Products . . . . .	-36	dB
5th Order Products . . . . .	-32	dB

- \* Approximate value.  
 \*\* Ref. against 1 tone of a 2-equal-tone signal.  
 # Plate voltage may rise to 2500 volts maximum under no-signal conditions to account for power supply regulation.  
 ## Measured at the load.  
 § Value will be lower with voice modulation for the same PEP level.

**PULSE MODULATOR OR REGULATOR**
**ABSOLUTE MAXIMUM RATINGS: (See Figure 2 PULSE DERATING CHART for pulse durations over 100 microseconds)**

DC PLATE VOLTAGE . . . . .	3500	VOLTS
AVERAGE PLATE DISSIPATION . . . . .	800	WATTS
PEAK PLATE CURRENT (average during pulse)	8	AMPERES
AVERAGE PLATE CURRENT . . . . .	0.6	AMPERE
AVERAGE GRID CURRENT . . . . .	0.06	AMPERE
GRID DISSIPATION (average) . . . . .	4	WATTS

TYPICAL OPERATION values are obtained by actual measurement or by calculation from published characteristic curves. Adjustment of the rf drive voltage to obtain the specified plate current at the specified bias and plate voltage is assumed. If this procedure is followed, there will be little variation in output power when the tube is replaced, even though there may be some variation in grid current. The grid current which occurs when the desired plate current is obtained is incidental and may vary from tube to tube. This current variation causes no performance degradation providing the circuit maintains the correct grid/cathode voltage in the presence of the current variation.



## APPLICATION

### MECHANICAL

**MOUNTING & SOCKETING** - The tube may be mounted in any position. If it is to be operated in an inverted (anode down) or horizontal position the SK-1916 clamp assembly should be used for reliable retention. The SK-1906 chimney is provided with four 4-40 tapped holes at one end for chassis mounting and four more 4-40 tapped holes at the other end for optional SK-1916 mounting. The combination of the SK-1906 with the optional SK-1916 clamp makes a rigid mounting assembly for the 3CX800A7. Outline drawings of the SK-1906 air chimney and the clamp assembly are shown in Fig.1.

**COOLING** - Forced-air cooling must be provided to maintain the anode core and seal temperatures at a safe operating temperature. Cooling data are shown for incoming cooling air at 25°C and 50°C, and represent the minimum requirements to limit tube temperatures to 225°C. The pressure drop figures are approximate and are for the mounting-plate (shown in Fig. 1), socket, tube and chimney combination as would be the case with pressurized-compartment mounting, where air is required to pass through the chassis slots and the anode cooler to the outside of the cabinet.

#### Cooling Air at 25°C

Anode Diss. W	SEA LEVEL		5000 FEET	
	Flow Rate cfm	Press. Drop In. Water	Flow Rate cfm	Press. Drop In. Water
400	6	0.09	7	0.10
600	11	0.20	14	0.23
800	19	0.50	23	0.57

#### Cooling Air at 50°C

Anode Diss. W	SEA LEVEL		5000 FEET	
	Flow Rate cfm	Press. Drop In. Water	Flow Rate cfm	Press. Drop In. Water
400	8	0.10	10	0.12
600	16	0.31	19	0.35
800	27	0.79	33	0.88

Some air from the pressurized compartment passes by the socket for base cooling. This mounting technique is effective in the HF region but rf leakage through the slots may cause amplifier instability or regeneration in the VHF region.

Screening the holes or use of "wave-guide-beyond-cutoff" (honeycomb) air vents may be required in the VHF region.

Cooling must be applied before or simultaneously with electrode voltages, including the heater, and may be removed simultaneously with them. In all cases temperature of the anode and the ceramic/metal seals is the limiting factor, and the designer is encouraged to use temperature-sensitive paint or other temperature sensing devices in connection with any equipment design before the layout is finalized. It should also be noted that it is not good practice to operate at, or close to, the absolute maximum temperature rating for the metal/ceramic seals. Where long life and consistent performance are factors cooling in excess of minimum requirements is normally beneficial.

### ELECTRICAL

**ABSOLUTE MAXIMUM RATINGS** - Values shown for each type of service are based on the "absolute system" and are not to be exceeded under any service conditions. These ratings are limiting values outside which serviceability of the tube may be impaired. In order not to exceed absolute ratings the equipment designer has the responsibility of determining an average design value for each rating below the absolute value of that rating by a safety factor so the absolute values will never be exceeded under any usual conditions of supply-voltage variation, load variation, or manufacturing variation in the equipment itself. It does not necessarily follow that combinations of absolute maximum ratings can be attained simultaneously.

**HEATER/CATHODE OPERATION** - The rated heater voltage for the 3CX800A7 is 13.5 volts, as measured at the base of the tube, and variations should be restricted to plus or minus 0.6 volt for long life and consistent performance.

**CATHODE WARMUP TIME** - In normal service it is recommended the heater voltage be applied for a minimum of three minutes before anode voltage and rf drive voltage are applied, to allow for proper conditioning of the cathode surface.

**HIGH VOLTAGE** - Normal operating voltages used with this tube are deadly. The equipment must be designed properly, and operating precautions must be followed. Design all equipment so that no one can

come in contact with high voltages. All equipment must include safety enclosures for high-voltage circuits and terminals, with interlock switches to open primary circuits of the power supply and to discharge high-voltage capacitors whenever access doors are opened. Interlock switches must not be bypassed or "cheated" to allow operation with access doors open. Always remember that HIGH VOLTAGE CAN KILL.

**INPUT CIRCUIT** - When this tube is operated as a grounded-grid rf amplifier, the use of a resonant tank in the cathode circuit is recommended to obtain greatest linearity and power output. For best results with a single-ended amplifier it is suggested that the cathode tank circuit operate at a "Q" of two or more.

**GRID AND PLATE CURRENT LIMITATIONS** - Note that grid current is a function of drive power and amplifier loading and can vary widely during tuning and loading. Under no circumstances should grid current exceed 60 mAdc during tuning or operation of the tube. The maximum plate current rating is 600 mAdc. Drive level should be restricted during tuning periods so this rating is not exceeded. For monitoring purposes, peak meter readings on voice (taking into account inertia of the meter) will be approximately 200 mAdc. Under no circumstances is the plate current meter reading to exceed the maximum plate current rating of 600 mAdc.

**INTERMODULATION DISTORTION** - Typical Operating Conditions, with distortion values included, are the result of data taken during actual operation at 2 MHz. Intermodulation values listed are those measured at the full peak-envelope power noted and are referenced against one tone of a two-equal-tone signal.

**FAULT PROTECTION** - All power tubes operate at voltages which can cause severe damage in the event of an arc, especially in cases where large amounts of power supply stored energy are involved. Some means of protection is advised in all cases, and it is recommended that a series resistor be used in the lead from the power supply to the anode circuit to limit peak current and help dissipate the energy in the event of a tube or circuit arc. A resistance of 50 ohms, with at least a 25W rating, in the positive plate power supply lead will help protect the tube in the event of an arc.

**VHF OPERATION** - The base pin connections to the grid may be used at frequencies to 30 MHz. Above 30 MHz the available contact collets or grid bypass capacitor assembly (see Page 1) are recommended. VHF driving power will be greater than the typical values shown on page 2 because of higher circuit losses.

**INTERELECTRODE CAPACITANCE** - The actual internal interelectrode capacitance of a tube is influenced by many variables in most applications, such as stray capacitance to the chassis, capacitance added by the socket used, stray capacitance between tube terminals, and wiring effects. To control the actual capacitance values within the tube, as the key component involved, the industry and Military Services use a standard test procedure as described in Electronic Industries Association Standard RS-191. This requires the use of a specially-constructed test fixture which shields all external tube leads or contacts from each other and eliminates any capacitance reading to "ground". The test is performed on a cold tube. Other factors being equal, controlling internal tube capacitance in this way normally assures good interchangeability of tubes over a period of time. The capacitance values shown in the technical data are taken in accordance with Standard RS-191. The equipment designer is therefore cautioned to make allowance for the actual capacitance values which will exist in his application. Measurements should be taken with the mounting which represents the approximate final layout if capacitance values are highly significant in the design.

**RADIO-FREQUENCY RADIATION** - Exposure to strong rf fields should be avoided, especially at frequencies above 300 MHz, where energy absorption by the human body is significant. The human eye is particularly sensitive. Prolonged exposure to rf radiation should be limited to 10 milliwatts per square centimeter (Occupational Safety & Health Administration (OSHA) standard). It is generally accepted that exposure to "high levels" of rf radiation can result in severe injury, including blindness. **CARDIAC PACEMAKERS MAY BE EFFECTED.**

**SPECIAL APPLICATIONS** - When it is desired to operate this tube under conditions widely different from those listed here, write to Varian EIMAC, attn: Product Manager, 301 Industrial Way, San Carlos, CA 94070 U.S.A.

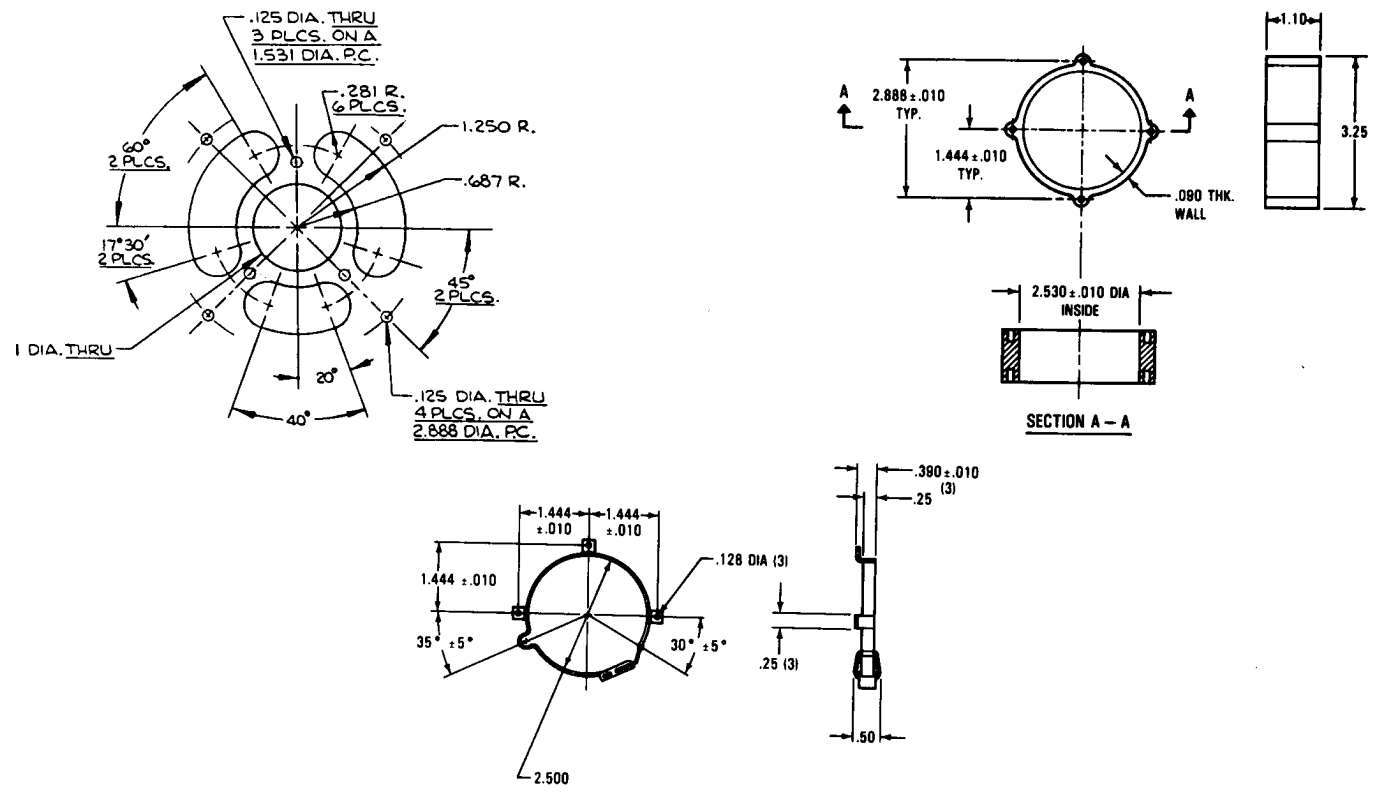

Figure 1 - Mounting Plate, Chimney SK-1906 and Clamp SK-1916, for SK-1900 Socket Assembly

OPERATING HAZARDS

PROPER USE AND SAFE OPERATING PRACTICES WITH RESPECT TO POWER TUBES ARE THE RESPONSIBILITY OF EQUIPMENT MANUFACTURERS AND USERS OF SUCH TUBES. ALL PERSONS WHO WORK WITH OR ARE EXPOSED TO POWER TUBES OR EQUIPMENT WHICH UTILIZES SUCH TUBES MUST TAKE PRECAUTIONS TO PROTECT THEMSELVES AGAINST POSSIBLE SERIOUS BODILY INJURY. DO NOT BE CARELESS AROUND SUCH PRODUCTS.

The operation of this tube may involve the following hazards, any one of which, in the absence of safe operating practices and precautions, could result in serious harm to personnel:

- a. HIGH VOLTAGE - Normal operating voltages can be deadly. Remember that HIGH VOLTAGE CAN KILL.
- b. LOW-VOLTAGE HIGH-CURRENT CIRCUITS - Personal jewelry, such as rings, should not be worn when working with filament contacts or connectors as a short circuit can produce very high current and melting, resulting in severe burns.
- c. RF RADIATION - Exposure to strong rf fields should be avoided, even at relatively low frequencies. The dangers of rf radiation are more severe at UHF and microwave frequencies and can cause serious bodily and eye injuries. CARDIAC PACEMAKERS MAY BE EFFECTED.
- d. HOT SURFACES - Surfaces of tubes can reach temperatures of several hundred °C and cause serious burns if touched for several minutes after all power is removed.

Please review the detailed operating hazards sheet enclosed with each tube, or request a copy from: Varian EIMAC, Power Grid Application Engineering, 301 Industrial Way, San Carlos CA 94070.

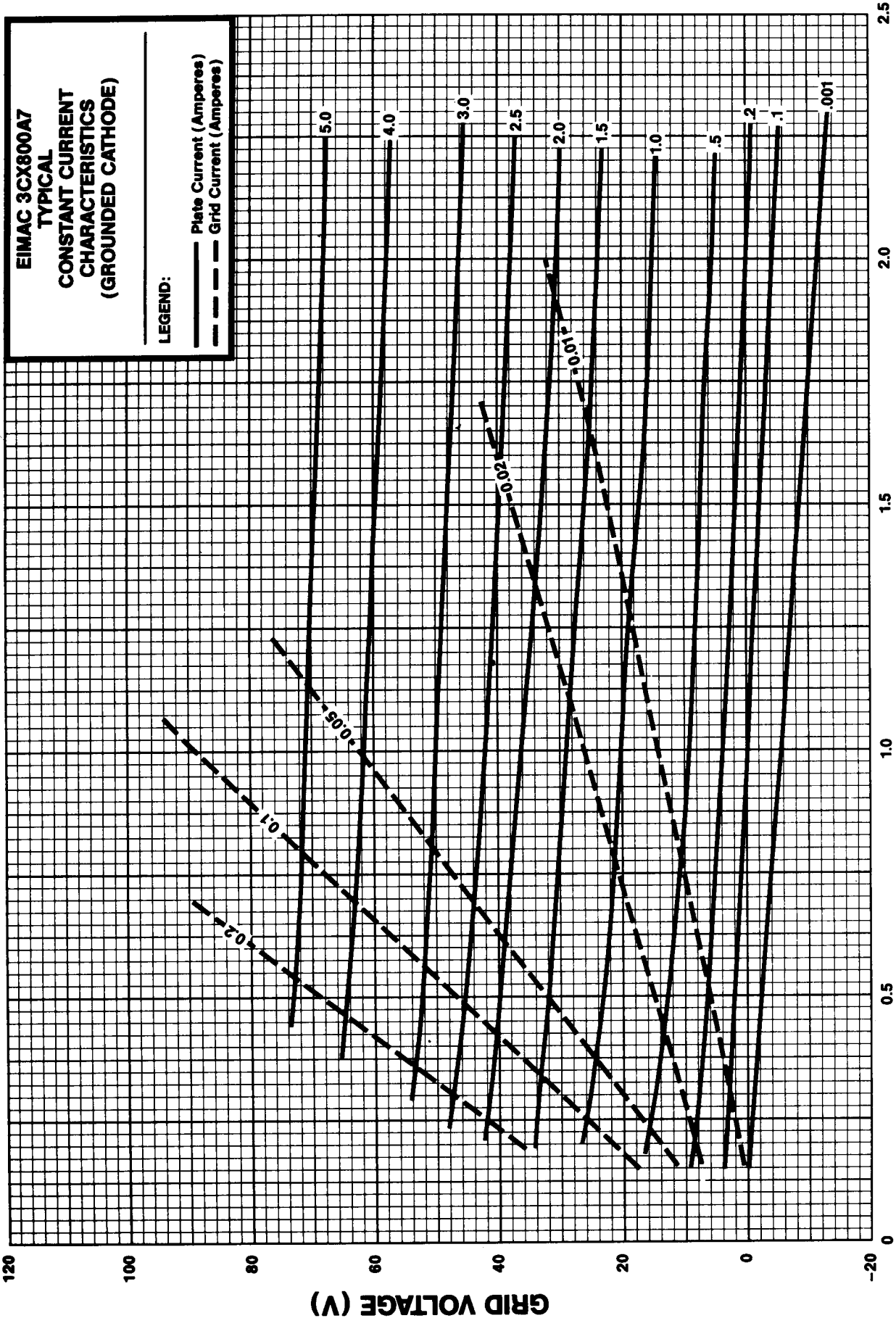

CURVE 005202

PLATE VOLTAGE (kV)

GRID VOLTAGE (V)

PLATE TO GRID VOLTAGE (kV)

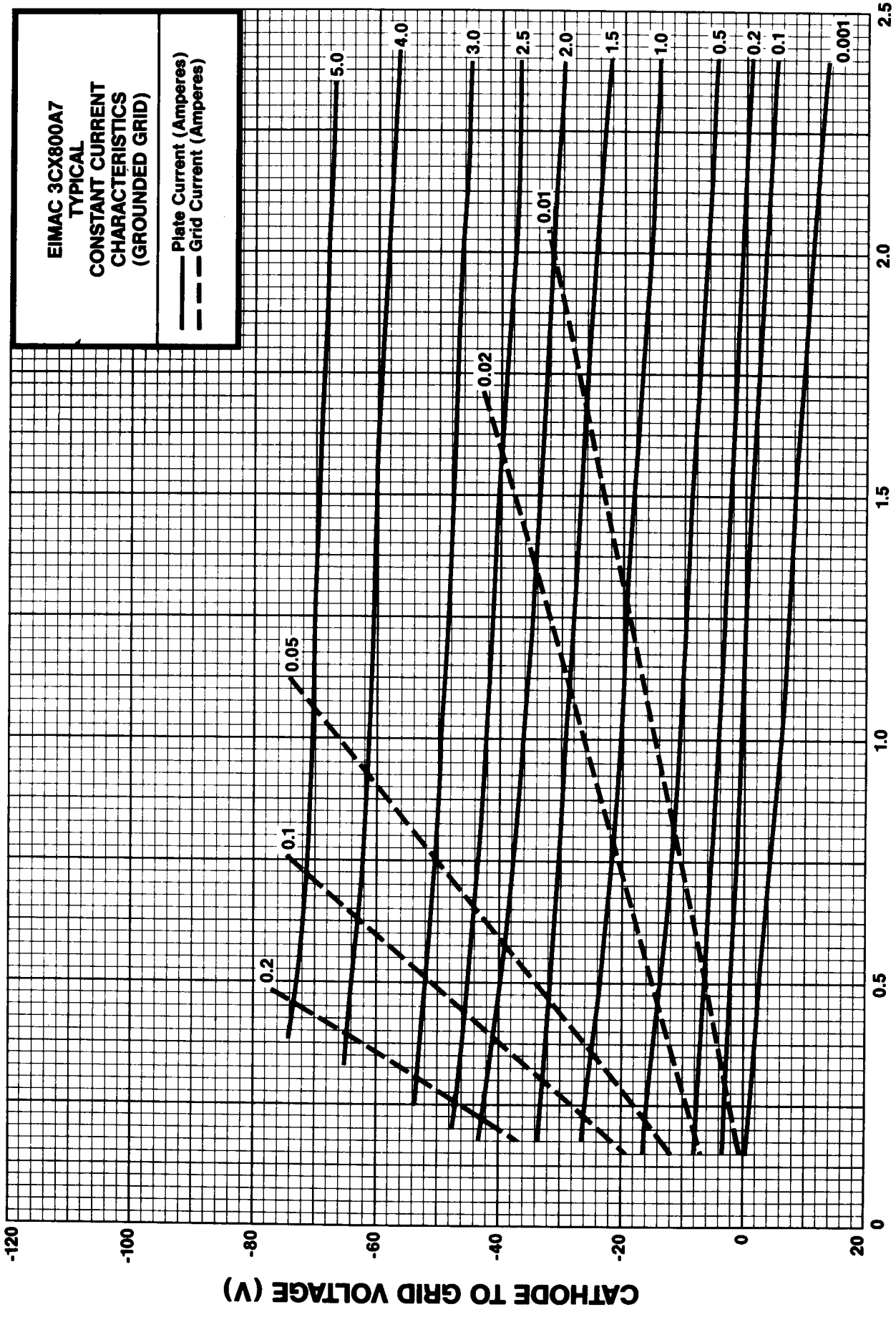

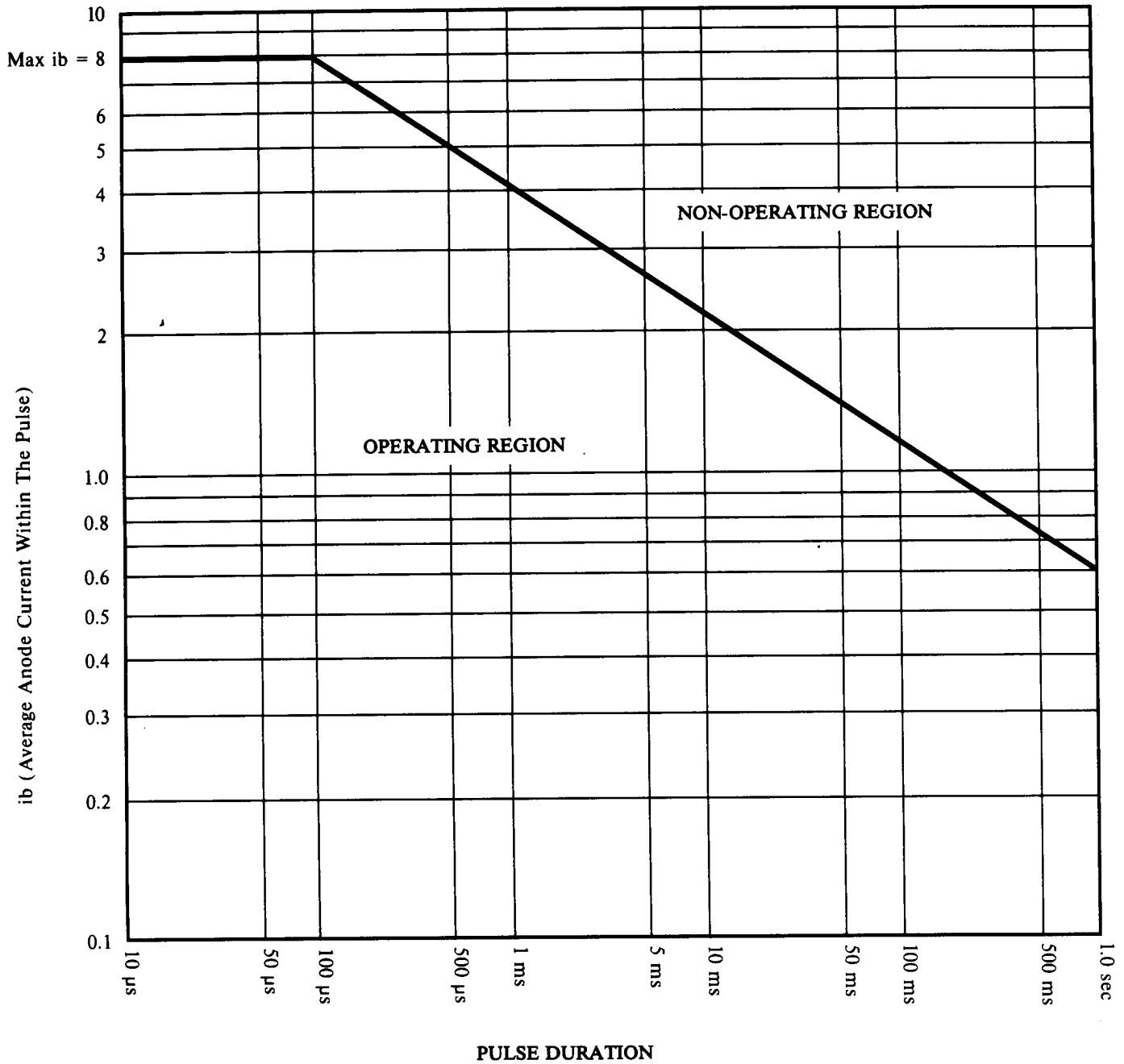

Figure 2 - Pulse Derating Chart, 3CX800A7  
Pulse Modulator or Regulator Service

Pulse anode current (ib) capability is dependent on pulse duration (tp) and duty factor (Du). Maximum ib for a given tp is shown; maximum Du may then be derived from the relationship:

$$0.6 = ib \sqrt{Du}$$





DIMENSIONAL DATA						
DIM	INCHES			MILLIMETERS		
	MIN	MAX	REF.	MIN	MAX	REF.
A	2.326	2.526		59.060	64.160	
B	2.485	2.515		63.119	63.981	
C	2.084	2.284		52.934	58.014	
D	.718	.838		18.237	21.285	
E	.710	.790		18.034	20.066	
F		1.406			35.712	
G	.187			4.750		
H	BASE: E11-81 ( JEDEC DESIGNATION )					
J	.559	.573		14.199	14.554	
K	.240			6.096		
L			.027			.686
M	1.417	1.433		35.992	36.398	

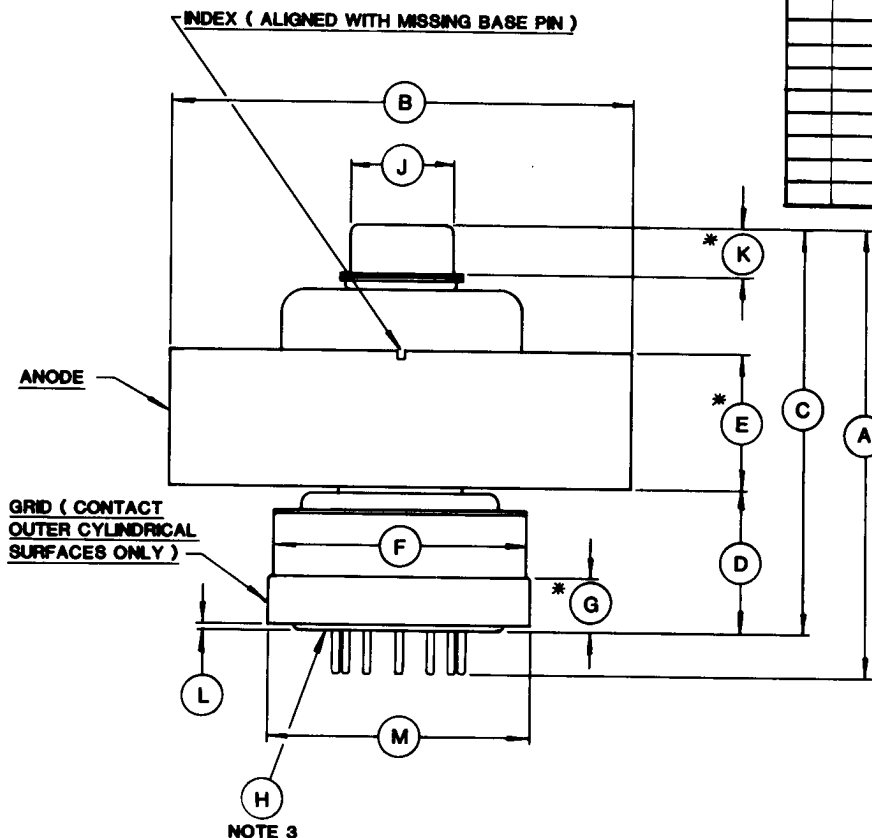

- NOTES:**
1. REF DIMENSIONS ARE FOR INFO ONLY & ARE NOT REQUIRED FOR INSPECTION PURPOSES.
  2. (\*) CONTACT SURFACES
  3. BASE IS BASIC JEDEC EXCEPT CERAMIC WAFER IS INSIDE SHELL

- PIN No. 1 CATHODE
- PIN No. 2 CATHODE
- PIN No. 3 CATHODE
- PIN No. 4 GRID
- PIN No. 5 HEATER
- PIN No. 6 HEATER
- PIN No. 7 GRID
- PIN No. 8 CATHODE
- PIN No. 9 CATHODE
- PIN No. 10 CATHODE
- PIN No. 11 GRID

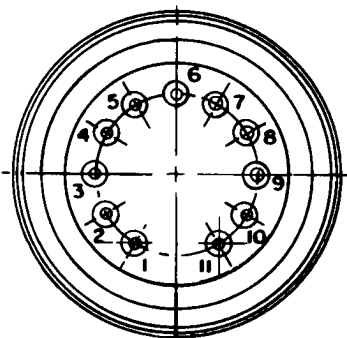



EIMAC UHF CAVITY AMPLIFIERS

EIMAC UHF CV-2400 series cavity amplifiers cover the range of 180 to 530 MHz. They are useful for communications service in the CW or FM mode. The designs incorporate the 3CX800A7 high-mu power triode for CW applications or the 3CPX800A7 in pulse applications.

Detailed information is shown for the CV-2401. Similar cavities available for other frequency ranges are listed.

CV-2407 . . . . .	180-200 MHz
CV-2403 . . . . .	280-300 MHz
CV-2405 . . . . .	330-370 MHz
CV-2402 . . . . .	375-420 MHz
CV-2406 . . . . .	450-470 MHz
CV-2404 . . . . .	470-530 MHz
CV-2408 . . . . .	585-615 MHz

Similar cavities can be adapted to specific requirements, including pulsed applications.

CV-2401 400 W POWER OUTPUT  
390-450 MHz

The CV-2401 is designed for use in the 390-450 MHz frequency range. It is designed for FM, CW or SSB linear amplifier service.

The amplifier tube is the EIMAC 3CX800A7, a high-mu triode designed with beam-forming cathode and control grid geometry. The tube is cathode driven for good linearity and high stage gain.

The triode design eliminates many cavity and equipment design complications associated with tet-rode cavities.

CHARACTERISTICS

Tuning Range . . . . .	390-450 MHz
Tube Type Used (not supplied) . . . . .	3CX800A7
Input rf Connector . . . . .	Type N
Output rf Connector . . . . .	Type N
Cooling Required . . . . .	Forced Air
Mounting Position . . . . .	Optional: normally mounts to fit 19-in Rack Panel

Overall Dimensions (nominal):

Height . . . . .	5.0 in; 12.7 cm
Width . . . . .	8.5 in; 21.6 cm
Depth . . . . .	8.25 in; 20.9 cm
Net Weight, approx. (tube not installed) . . . . .	13 lbs; 6.0 kg

TYPICAL OPERATION (450 MHz)

Heater Voltage . . . . .	13.5	Vac
Heater Current * . . . . .	1.5	Aac
Anode Voltage . . . . .	1800	Vdc
Grid Bias Voltage . . . . .	-8.0	Vdc
Anode Current . . . . .	0.48	Adc
Grid Current * . . . . .	10	mAdc
Driving Power * . . . . .	15	W
Useful Power Output * # . . . . .	400	W
Power Gain * . . . . .	14.2	dB
Efficiency . . . . .	46	%

\* Approximate value      # Power delivered to the load