

SVETLANA TECHNICAL DATA

3CX400A7/8874

High-Mu Power Triode



The Svetlana™ 3CX400A7/8874 is a high performance ceramic/metal power triode designed for use in communications, paging and commercial service. The principal use is as an RF amplifier, in Class A, B or C service. The Svetlana 3CX400A7/8874 may also be operated as a pulse modulator with an increase in maximum plate voltage up to 3500 volts. Maximum plate current is 6 amps at a pulse duration of 100 microseconds.

The Svetlana 3CX400A7/8874 is a direct replacement for the model 3CX400A7/8874 manufactured in the United States.

Characteristics

Electrical

Cathode:	Oxide-coated unipotential	
Heater voltage (AC or DC)	6.3 ± 0.3	V
Heater current @ 6.3V	3.0	A
Transconductance (average)	29,000	μmhos
Maximum frequency at full ratings	500	MHz
Interelectrode capacitances, with cathode grounded:		
Input	20.5	pF
Output	0.03	pF
Grid-Plate	6.0	pF
Interelectrode capacitances, with grid grounded:		
Input	20.5	pF
Output	6.0	pF
Plate-Cathode	.03	pF

Mechanical

Cooling	Forced air	
Base	11 pin with ring EIA No. E11-81	
Socket	E.F. Johnson #124-311-100	
Operating position-	Vertical, base up or down	
Nominal dimensions:		
Diameter	41.7 mm (1.64 in.)	
Length	54.6 mm (2.15 in.)	
Maximum operating temperature	250° C	
Net weight (average)	122 g (0.269 lb.)	

Maximum ratings

DC plate voltage	2200	V
Maximum-signal DC plate current	350	mA
Plate Dissipation	400	W
Grid Dissipation	5	W

Svetlana Outline drawing

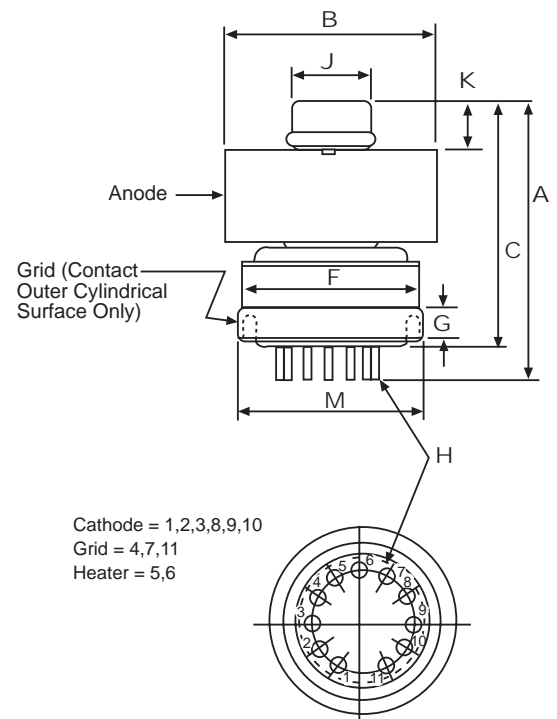

Dimensional Data

Dim.	Millimeters		Inches	
	Min.	Max.	Min.	Max.
A	50.85	54.41	2.002	2.142
B	40.89	41.66	1.610	1.640
C	45.97	48.51	1.810	1.910
F	—	35.71	—	1.406
G	4.75	—	0.187	—
H	BASE: E11-81 (EIA DESIGNATION)			
J	13.75	14.55	0.541	0.573
K	6.10	—	0.240	—
M	35.99	36.40	1.417	1.433



Svetlana
ELECTRON DEVICES

Headquarters:

8200 South Memorial Parkway
Huntsville, AL 35802
USA
Phone: 205 882 1344
Fax: 205 880 8077

Marketing & Engineering:

3000 Alpine Road
Portola Valley, CA 94028
USA
Phone: 415 233 0429
Fax: 415 233 0439

www.svetlana.com

Svetlana 3CX400A7/8874 High-Mu Power Triode



Svetlana
ELECTRON DEVICES

Typical Operation, Class AB₂ Cathode Driven

Frequency in MHz		30	150	432
DC plate voltage		2000	2000	2000
V				
Cathode voltage		8.2	9.8	8.2
V				
Peak RF grid-cathode voltage	67	50	67	V
Two tone plate current	312	245	300	mA
Zero signal plate current	22	10	22	mA
Two tone grid current	12	10	39	mA
Peak RF driving power	26	18	27	W
Power output (approx.)	587	526	505	W

Cooling Data

Anode Dissipation Watts	Air Flow CFM	Pressure Drop Inches of Water
200	4.0	0.11
300	6.0	0.22
400	8.6	0.37

Heater/Cathode Operation

Frequency MHz	Heater Voltage
<300	6.3
301-400	6.0
401-500	5.7

