

T.			$U_f$	$I_f$	$U_a$	$U_{g2}$	$U_{g1}$	$I_a$	$I_{g2}$	$S$	$R_i$	$U_{f/k}$	$P_a$	$P_{g2}$
			V	A	V	V	V	mA	mA	mA/V	MΩ	V	W	W
3 DT 6	amer	1	3,15	0,6	150	100	$R_k^1)$	1,1	2,1	0,8	0,15	200	1,5	1
4 DT 6	amer	1	4,2	0,45										
6 DT 6	amer	1	6,3	0,3										
36	amer	4	6,3	0,3	250	90	-3	3,2	1,7	1,1	0,55			
954	int	3	6,3	0,15	90	90	-3	1,2	0,5	1,1	1	(A 1)		
4676	eur	3	4	0,235	250	100	-3	2	0,7	1,4	1	(A 1)		
9001	int	2	6,3	0,15	250	100	-5	maximum ( $f = 430 \text{ MHz}$ )			0,55	80	0,8	0,1

<sup>1)</sup>  $R_k = 560 \Omega$

T.	$C_{g1/a}$	$C_{g1/k}$	$C_{a/k}$	$C_{g3/a}$	$C_{g1/g3}$	$C_{g3/k}$
	pF	pF	pF	pF	pF	pF
3/6 DT 6	0,02	5,8		1,4	0,1	6,1
954	0,007	3,4	3			
4676	0,01	3	2,7			
9001	0,01	3,6	3			

Equivalentents

A 41	Maz = 4676	6 Ж 1 Ж	СССР=954
AP 4	Mul = 4676	36 A	amer = 36
E 1 F	Phl = 954	136	amer = 36
Z 2	Tif = 4676	236	amer = 36
ZA 1	MOG = 4676	336	amer = 36
ZA 2	MOG = 954	4672	eur = 954

$U_b$	$R_a$	$R_{g2}$	$R_k$	$I_a$	$I_{g2}$	$U_{a\approx}$	$\mu$	$h$
V	MΩ	MΩ	kΩ	mA	mA	V	$U_{a\approx}/U_{g\approx}$	%
90	0,3	0,6	10	0,13	0,08	5	70	2,8
90	0,2	0,3	8	0,2	0,06	5	63	3,1
90	0,1	0,16	5	0,3	0,09	5	47	3,9
90	0,05	0,1	5	0,34	0,19	5	34	5,8
250	0,3	1,0	4	0,47	0,11	14	184	1,4
250	0,2	0,64	2,5	0,73	0,17	14	165	2,0
250	0,1	0,4	1,6	1,22	0,27	14	115	2,8
250	0,05	0,2	1	1,74	0,4	14	78	3,5

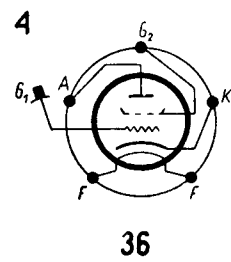
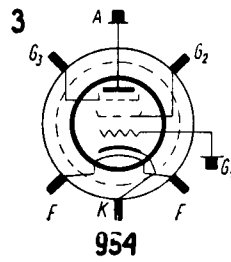
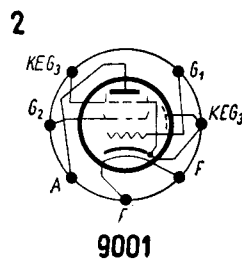
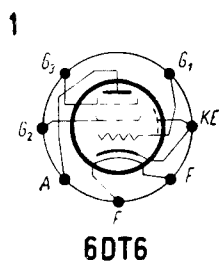
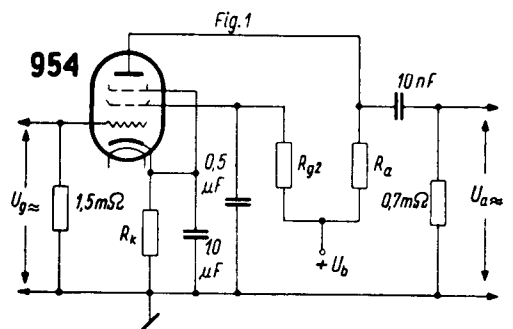

Fig. 2 Detektor

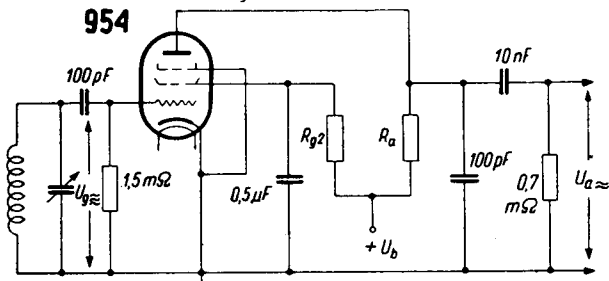
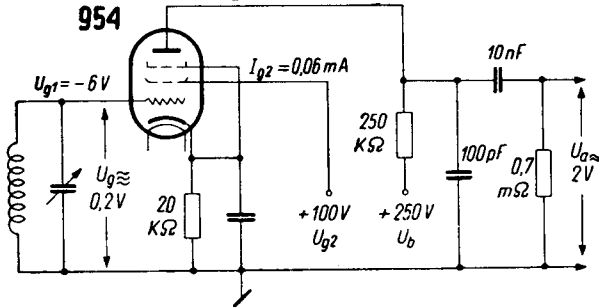

Fig. 3 Detektor  
 $I_a = 0.1 \text{ mA}$



$U_b$	$R_a$	$R_{g2}$	$I_a$	$I_{g2}$	$U_{a \approx}$	$\mu$	$h$
V	MΩ	MΩ	mA	mA	V	$U_{a \approx}   U_{g \approx}$	%
90	0,3	1,0	0,14	0,07	4,7	6	3
90	0,2	0,5	0,25	0,13	3,6	5,6	4
90	0,1	0,1	0,51	0,28	2,7	4,8	5,4
90	0,05	0,1	0,84	0,46	2,1	4,7	6,2
250	0,3	1,0	0,48	0,11	7,7	14	1
250	0,2	0,64	0,77	0,18	7,6	14	1,8
250	0,1	0,4	1,28	0,25	6,2	11,5	2,3
250	0,05	0,25	1,85	0,39	4,5	8,5	2,5

